



## COMPLETE PRODUCT LINE

Manufacturer of Pumps, Tanks,  
Heat Exchangers & Accessories



**PUMPS**



**PACKAGES**



**ACCESSORIES**

# HISTORY

Flo Fab was established in 1981 by Denis Gauvreau who created and developed the product line, which is constantly being perfected by Marc Gauvreau and a team of professional engineers and designers. It is a combination of existing designs from several renowned products and the innovative ideas of a new generation professionals.

Founder 1981

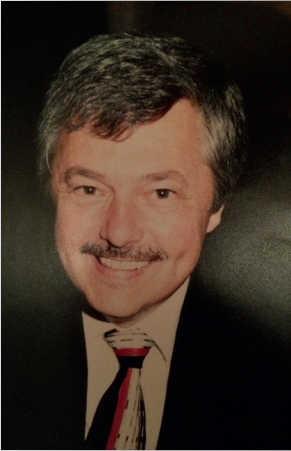

Through the years, Flo Fab has acquired several companies and service entities including: AQUA-PROFAB (ASME Tanks manufacturer), MÉNARD, LÉONARD ÉLECTRIQUE, PMA. Moreover, Flo Fab also purchased equipment, fabrication designs and patterns from IDEALCO, a manufacturer of shell and tube type heat exchangers.

The after-sales services, sales, engineering, R&D, production, quality control, accounting and administration departments of all the above companies share the same location.

In December 2014, Marc Gauvreau, son of the founder, acquired all of the company's shares. Flo Fab and is constantly investing in new state-of-the-art innovations, new products like the XRI series and Prefab Skid for Hydronic Heating & cooling system and pumping systems. This has allowed Flo Fab to retain our competent and qualified staff of professionals with a variety of specialized skills that continually work on improving our existing products and adding new engineered solutions that exceed customers' expectations .





Flo Fab has grown quite rapidly and now proudly offers of a wide range of products available directly from one manufacturer. This includes pumps and pump packages, tanks, heat exchangers and hydronic accessories. This allows each project's stakeholders to enjoy economical savings, peace of mind, best value for their investment and optimized total cost of ownership.

A handwritten signature in cursive script, consisting of the letters 'M' and 'G'.

## TABLE OF CONTENTS

<b>VERTICAL IN-LINE PUMPS.....</b>	<b>3</b>
<b>FEATURE PRODUCT.....</b>	<b>3</b>
<b>SERIES XRI VARIOUS CONFIGURATIONS.....</b>	<b>4</b>
<b>HORIZONTAL BASE MOUNTED &amp; CLOSE COUPLED END SUCTION PUMPS.....</b>	<b>5</b>
<b>SPLIT CASE DOUBLE SUCTION / MULTISTAGE / CLOSE COUPLED STAINLESS PUMPS...</b>	<b>5</b>
<b>CONDENSATE &amp; TURBINE PUMPS.....</b>	<b>6</b>
<b>ASME TANKS &amp; AIR SEPARATORS.....</b>	<b>7</b>
<b>HEAT EXCHANGERS.....</b>	<b>6</b>
<b>HOW TO PRICE A PACKAGE.....</b>	<b>7</b>
<b>ALL SUBMERSIBLES.....</b>	<b>8-21</b>
<b>TYPICAL MECHANICAL ROOM.....</b>	<b>22</b>
<b>HYDRONIC ACCESSORIES.....</b>	<b>23</b>
<b>SUBMERSIBLE PUMPS (PLUMBING).....</b>	<b>24</b>
<b>PACKAGED SYSTEMS.....</b>	<b>25-27</b>
<b>DIFFERENT SYSTEMS.....</b>	<b>28-29</b>
<b>COMPLETED AND ONGOING PROJECTS.....</b>	<b>30</b>



				
<b>SERIES</b>	<b>500</b>	<b>600</b>	<b>840SC</b>	<b>880RI</b>
<b>TYPE</b>	Circulating Pump	In-Line Circulator	Vertical In-Line Centrifugal Split Coupling	Vertical In-Line Centrifugal Split Coupling
<b>CAPACITIES</b>	up to 234 USGPM (54 m <sup>3</sup> /hr)	up to 290 USGPM (61 m <sup>3</sup> /hr)	454 to 8000 USGPM (1816 m <sup>3</sup> /hr)	Up to 3000 USGPM (680 m <sup>3</sup> /hr)
<b>HEAD</b>	up to 43 ft. (14 m)	up to 120 ft. (37 m)	up to 410 ft. (125 m)	up to 650 ft. (198 m)
<b>PRESSURE</b>	up to 145 PSI (999 kPa)	up to 250 PSI (1724 kPa)	up to 600 PSI (4136 kPa)	up to 250 PSI (1724 kPa)
<b>HORSEPOWER</b>	up to 2/5 HP (280 kW)	up to 10 HP (7.5 kW)	up to 400 HP (298 kW)	up to 200 HP (149kW)
<b>DRIVES</b>	ECM Motor ERP Ready	56C Electric Motors	TC Electric Motors	TC Electric Motors
<b>APPLICATIONS</b>	Water / Glycol	Water / Glycol	Water / Glycol	Water / Glycol
<b>TEMPERATURE</b>	up to 220°F (104°C)	up to 250°F (121°C)	up to 300°F (149°C)	up to 300°F (149 °C)
<b>CONSTRUCTION MATERIAL</b>	Cast Iron, Stainless, Bronze	Cast Iron, Bronze Fitted or All Bronze	Cast Iron, Bronze Fitted as Standard. Other materials also available	Cast Iron, Bronze Fitted as Standard. Other materials also available

	
<b>SERIES</b>	<b>XRI</b>
<b>TYPE</b>	Universal 10 positions Vertical / Horizontal Centrifugal Pump with removable Impeller
<b>CAPACITIES</b>	up to 15850 USGPM 3600 m <sup>3</sup> /hr
<b>HEAD</b>	up to 655ft (200m)
<b>PRESSURE</b>	up to 600 PSI (4136 kPa)
<b>HORSEPOWER</b>	up to 1000 HP (746 kW)
<b>DRIVES</b>	TC Electric Motors
<b>APPLICATIONS</b>	Water / Glycol
<b>TEMPERATURE</b>	up to 300°F (149°C)
<b>CONSTRUCTION MATERIAL</b>	Cast Iron, Bronze Fitted as Standard. Other materials also available

## - FEATURE PRODUCT -

### VERTICAL POSITION

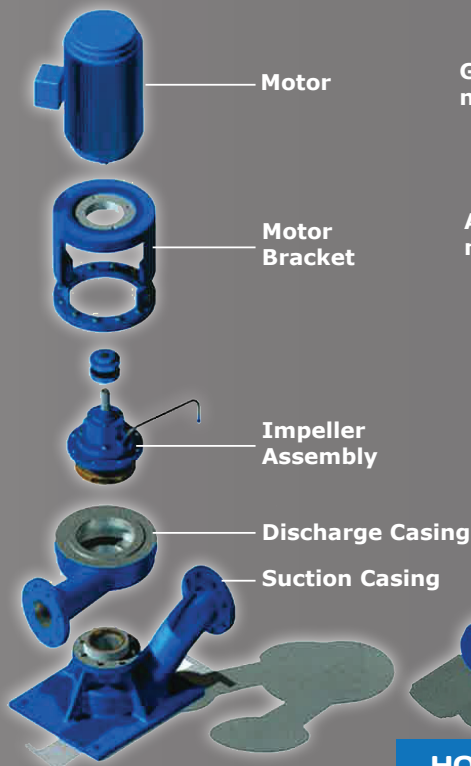

Series XRI construction

Grout not required



Alignment not required

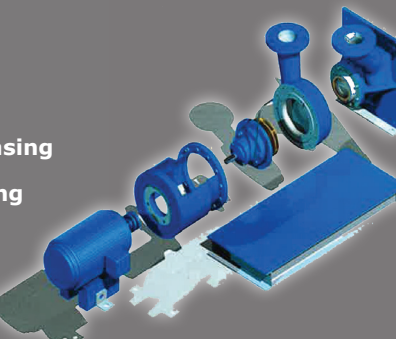

### HORIZONTAL POSITION

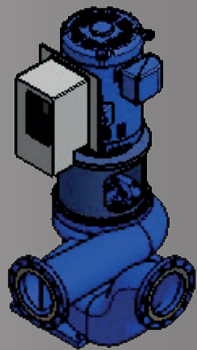

CV

**CROSSED VERTICAL**

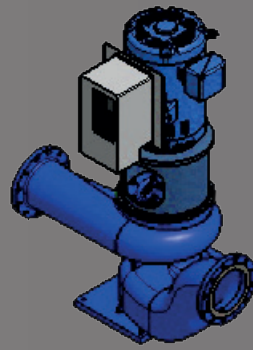

IV

**IN-LINE VERTICAL**

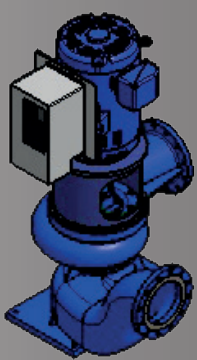

LV

**L-SHAPED VERTICAL**

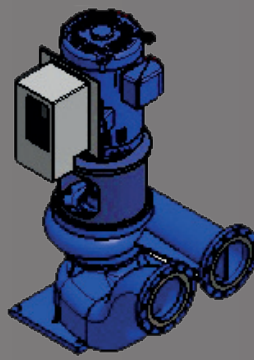

UV

**U-SHAPED VERTICAL**

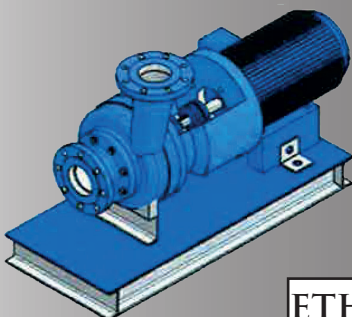

ETH

**END SUCTION TOP HORIZONTAL**

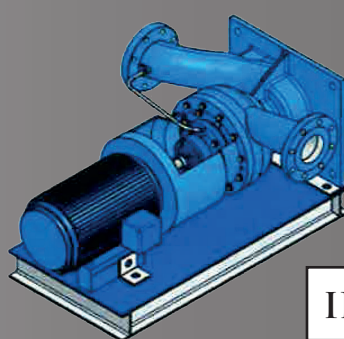

IH

**IN-LINE HORIZONTAL**

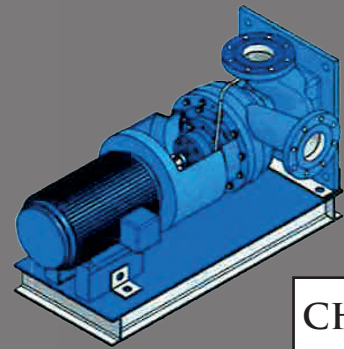

CH

**CROSSED HORIZONTAL**

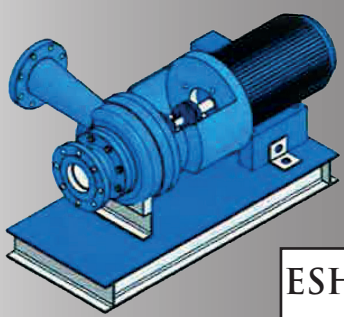

ESH

**END SUCTION HORIZONTAL**

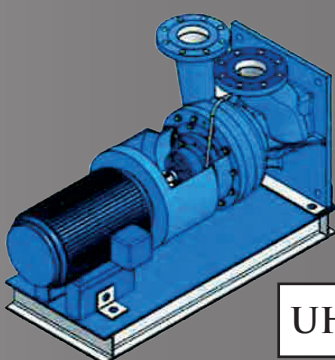

UH

**U-SHAPED HORIZONTAL**

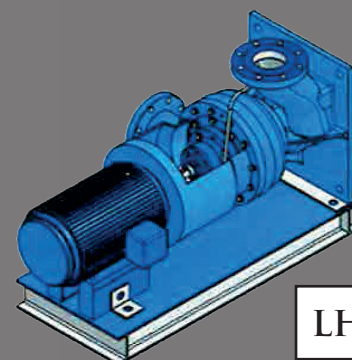







LH

**L-SHAPED HORIZONTAL**

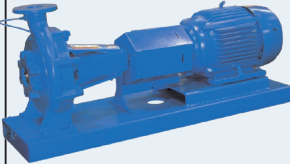









**VERTICAL IN-LINE, HORIZONTAL BASE MOUNTED, CLOSED COUPLED, AND SPLIT CASE DOUBLE SUCTION TYPE PUMPS**

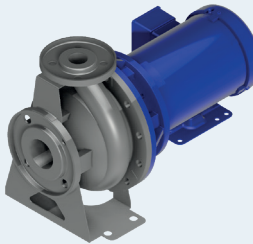



				
<b>SERIES</b>	<b>880</b>	<b>1000/1004</b>	<b>2000</b>	<b>2300 / 2600</b>
<b>TYPE</b>	Compact In-Line Centrifugal	End Suction, Close Coupled	Radially Split Bearing Frame Pump Mounted With Flexible Coupling Back PULL-OUT Design	Radially Split Bearing Frame Pump Mounted With Flexible Coupling Back PULL-OUT Design
<b>CAPACITIES</b>	up to 3000 USGPM (680 m <sup>3</sup> /hr)	up to 1900 USGPM (431 m <sup>3</sup> /hr)	up to 1900 USGPM (431 m <sup>3</sup> /hr)	from 1900 to 6500 USGPM (432 to 1476 m <sup>3</sup> /hr)
<b>HEAD</b>	up to 650 ft. (198 m)	up to 43 ft. (14 m)	up to 120 ft. (37 m)	up to 410 ft. (125 m)
<b>PRESSURE</b>	up to 250 PSI (1724 kPa)	up to 175 PSI (1206 kPa)	up to 175 PSI (1206 kPa) with 125# flanges	up to 400 PSI (1206 kPa) with 400# flanges
<b>HORSEPOWER</b>	up to 200 HP (149 kW)	up to 200 HP (149 kW)	up to 200 HP (149 kW)	up to 500 HP (373 kW)
<b>DRIVES</b>	JM Electric Motors	JM Electric Motors	T Frame Electric Motors or Diesel Engines	T Frame Electric Motors or Diesel Engines
<b>APPLICATIONS</b>	Water / Glycol	Water / Glycol	Water / Glycol	Water / Glycol
<b>TEMPERATURE</b>	up to 300°F (149 °C)	up to 300°F (149 °C)	up to 300°F (149 °C)	up to 300°F (149 °C)
<b>CONSTRUCTION MATERIAL</b>	Cast Iron, Bronze Fitted as Standard. Other materials also available	Cast Iron, Bronze Fitted as Standard. Other materials also available	Cast Iron, Bronze Fitted as Standard. Other materials also available	Cast Iron, Bronze Fitted as Standard. Other materials also available

				
<b>SERIES</b>	<b>4800L</b>	<b>4800U</b>	<b>4800/4800H/4900</b>	<b>4800V</b>
<b>TYPE</b>	Single Stage, Double Suction Split Case	Single Stage, Double Suction Split Case	Horizontally Mounted, Single Stage, Double Suction Split Case	Vertically Mounted, Single Stage, Double Suction Split Case
<b>CAPACITIES</b>	up to 12000 USGPM (2725 m <sup>3</sup> /hr)	up to 12000 USGPM (2725 m <sup>3</sup> /hr)	up to 12700 USGPM (2884 m <sup>3</sup> /hr)	up to 12700 USGPM (2884 m <sup>3</sup> /hr)
<b>HEAD</b>	up to 750 ft. (227 m)	up to 750 ft. (227 m)	up to 625 ft. (190 m)	up to 625 ft. (190 m)
<b>PRESSURE</b>	up to 600 PSI (4136 kPa)	up to 600 PSI (4136 kPa)	up to 600 PSI (4136 kPa)	up to 600 PSI (4136 kPa)
<b>HORSEPOWER</b>	up to 800 HP (597 kW)	up to 800 HP (597 kW)	up to 1750 HP (1305 kW)	up to 1750 HP (1305 kW)
<b>DRIVES</b>	Electric Motors, Diesel Engines, Steam Turbines	Electric Motors, Diesel Engines, Steam Turbines	Electric Motors, Diesel Engines, Steam Turbines	Electric Motors, Diesel Engines, R.A.G.D
<b>APPLICATIONS</b>	Water / Glycol	Water / Glycol	Water / Glycol	Water / Glycol
<b>TEMPERATURE</b>	up to 300°F (149°C)	up to 300°F (149°C)	up to 300°F (149°C)	up to 300°F (149°C)
<b>CONSTRUCTION MATERIAL</b>	Cast Iron, Bronze Fitted as Standard. Other materials also available	Cast Iron, Bronze Fitted as Standard. Other materials also available	Cast Iron, Bronze Fitted as Standard. Other materials also available	Cast Iron, Bronze Fitted as Standard. Other materials also available

**MULTISTAGE AND CLOSED COUPLED STAINLESS STEEL TYPE PUMPS  
SHELL AND TUBE, PLATE AND FRAME, BRAZED TYPE HEAT EXCHANGERS**

				
<b>SERIES</b>	<b>PSMCF</b>	<b>PSM</b>	<b>PSF</b>	<b>PST</b>
<b>TYPE</b>	Vertical Multistage	Vertical Multistage	Flanged Close Coupled Centrifugal	NPT Close Coupled Centrifugal
<b>CAPACITIES</b>	up to 250 USGPM (56 m <sup>3</sup> /hr)	up to 792 USGPM (180 m <sup>3</sup> /hr)	13 to 380 USGPM (3 to 86 m <sup>3</sup> /hr)	up to 52 USGPM (12m <sup>3</sup> /hr)
<b>HEAD</b>	up to 930 ft. (283 m)	up to 930 ft. (283 m)	up to 150 ft. (46 m)	up to 150 ft. (46 m)
<b>PRESSURE</b>	up to 430 PSI (2964 kPa)	up to 430 PSI (2964 kPa)	up to 145 PSI (1000 kPa)	up to 115 PSI (793 kPa)
<b>HORSEPOWER</b>	up to 50 HP (37 kW)	up to 100 HP (75 kW)	up to 15 HP (11 kW)	up to 3 HP (2.2 kW)
<b>DRIVES</b>	Vertical Electrical Motor	Vertical Electrical Motor	Electric Close Coupled Motors	Vertical Electrical Motor
<b>APPLICATIONS</b>	Water and Clear Liquids	Water and Clear Liquids	Water and Clear Liquids	Water and Clear Liquids
<b>TEMPERATURE</b>	5°F (-15°C) to 248°F (120°)	5°F (-15°C) to 248°F (120°)	up to 225°F (107°C)	up to 225°F (107°C)
<b>CONSTRUCTION MATERIAL</b>	#304 Stainless Steel Optional #316 S/S	Cast Iron as Standard, or Stainless Steel #304 & #316	#304 Stainless Steel	#304 Stainless Steel

				
	<b>Shell and Tube Heat Exchangers</b>		<b>Plate and Frame Heat Exchangers</b>	<b>Brazed Heat Exchangers</b>
<b>SERIES</b>	"W"	"S"	"FFW" AHRI	"BR"
<b>TYPE</b>	Water to Water / Glycol to Water	Steam to Water	Steam to Water Water to Water Glycol to Water	Steam to Water Water to Water Glycol to Water
<b>CAPACITIES</b>	up to 3000 USGPM 681 m <sup>3</sup> /hr up to 250 PSI (1724 kPa) Steam	up to 10000 USGPM 2271 m <sup>3</sup> /hr up to 250 PSI (1724 kPa) Steam	up to 400 USGPM 91 m <sup>3</sup> /hr up to 150 lbs Steam	150% for 60 sec. (HD), 120% for 60 sec. (ND)
<b>PRESSURE</b>	150 PSI (1034 kPa) 250 PSI (1724 kPa)	300 PSI (2068 kPa)	300 PSI (up to 2068 kPa)	
<b>APPLICATIONS</b>	Water, Glycol or Steam	Water, Glycol or Steam	Water, Glycol or Steam	
<b>TEMPERATURE</b>	up to 300°F (144°C)	up to 300°F (144°C)	up to 300°F (144°C)	
<b>CONSTRUCTION MATERIAL</b>	Carbon Steel or Stainless Steel with Stainless Steel Tubes	Carbon Steel, Titanium and Stainless Steel. Other materials available	Titanium and Stainless Steel. Other materials available	

					
<b>SERIES</b>	<b>SEP</b>	<b>ADSR/AD</b>	<b>RDT/BT</b>	<b>RLU / RWU</b>	<b>RSE</b>
<b>TYPE</b>	Vortex - Tangential Air Separator (With or Without Strainer)	In-Line Air/Dirt Separator (With Strainer)	Non Replaceable Bladder Expansion Tank Replaceable Bladder Exp. Tank (with bottom system connection)	Hot Water Storage Tank with Heater	Hot Water Storage Tank
<b>CAPACITIES</b>	56 to 67000 USGPM (13 to 15217 m <sup>3</sup> /hr)	69 to 12100 USGPM (16 to 2748 m <sup>3</sup> /hr)	3 to 3962 Gallons (11 to 15000 litres)	100 to 15000 Gallons (379 to 56781 litres)	
<b>CONNECTIONS</b>	2" to 36" Diameter (50 mm to 914 mm)	2" to 36" Diameter (50 mm to 914 mm)	1" to 3" 25 mm to 75 mm	As Requested	
<b>PRESSURE</b>	up to 250PSI (1724 kPa)	up to 250PSI (1724 kPa)	up to 250PSI (1724 kPa)	up to 250PSI (1724 kPa)	
<b>TEMPERATURE</b>	up to 550°F (288°C)	up to 550°F (288°C)	up to 240°F (115°C)	up to 550°F (288°C)	
<b>CONSTRUCTION MATERIAL</b>	Carbon Steel or Stainless Steel	Carbon Steel or Stainless Steel	Carbon Steel EPDM	Carbon Steel or Stainless Steel	

## Quotation Requirement

### What we need? for Skid

- 1.1 System PID
- 1.2 Pumps, Tanks and Heat Exchangers Schedule
- 1.3 Cut sheets for non Flo Fab parts such as Boilers, Chillers, etc...
- 1.4 Skids footprint
- 1.5 Mechanical room footprint
- 1.6 Control sequence details



### Quality Control

All pumps are factory tested and certified performance test is available when requested by the consultant. Test facilities up to 400 HP with 27,000-gallon test bench with calibrated instruments.

### Skid Advantages

- Solution for both: New construction and Retrofit.
- Easily add more modules for future expansion.
- One single point of Responsibility / Contact.
- One single submittal for approval vs. individual submittals for each component.
- Financial: Cost reduction. Effectively reduce total cost of ownership for all project stakeholders (Contractor / Consultant Engineer / End User)
- Financial: Space saving due to optimized space utilisation.
- Financial: Time (Cost) saving : Skid built in parallel during building construction, also .
- Financial: Cash flow
- Management: One single invoice / payment for all works
- Financial: Overhead savings, including project management, logistical coordination, insurance expense, etc.

PID:

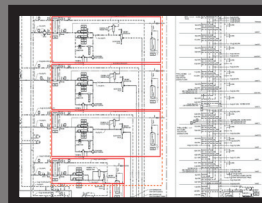

Production:



Package:

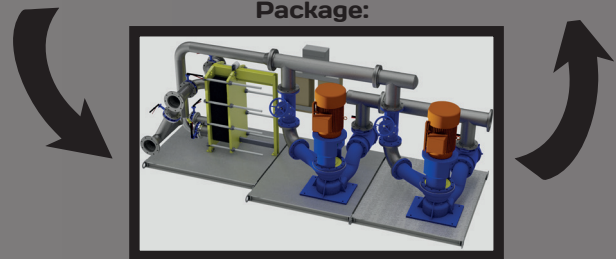

#### 2.1 Heating and Cooling Systems

2.2 HC Module will be composed of two pumps, control panel VFD, expansion tank, air separator, chemical pot feeder, and glycol fill system (optional), balancing valves, isolation valves, air vents and drain connections, multifunction valves, suction diffusers or Y strainers, interconnecting black steel schedule 40 piping. All package components are mounted on a structural steel base with lifting lugs.

#### SPECS example:

Product	Product Type	Section(s)	Date Submitted	Status	
XRI	Separately Coupled, Horizontally Mounted, In-Line Centrifugal Pumps	232123-HYDRONIC PUMPS	1/5/2016	Submitted	<a href="#">View Details</a>
880RI	Separately Coupled, Vertically Mounted, In-Line Centrifugal Pumps	232123-HYDRONIC PUMPS	1/5/2016	Submitted	<a href="#">View Details</a>
2000	Separately Coupled, Base-Mounted, End-Suction Centrifugal Pumps	232123-HYDRONIC PUMPS	1/5/2016	Submitted	<a href="#">View Details</a>

- Financial: No surplus or extra components left after fabrication by contractor.
- Time (Cost) saving: No construction delay due to tested = site plug & play
- Safety: Avoid unpleasant site safety incidents and lost days as we tremendously minimize job site man-hours.





## **FFBP33 & FFBP50**

Discharge: 1½" NPT, female, vertical.

Spherical solids handling: 1/2"

HP: 0.3 & 0.5

RPM: 3500

Impeller: 10 vane vortex, with vanes on back side, dynamically balanced. Cast iron ASTM A-48, class 30.

Shaft: 416 series stainless steel.

Motor: NEMA L, single phase, permanent split capacitor, 120 volts, 60 Hz, oil filled, with overload protection in motor.

Pump operation: automatic float switch or automatic vertical float switch.



## **FF2AHS**

Discharge: 2" NPT, vertical.

Spherical solids handling: 1/2"

HP: 1

RPM: 3500

Impeller: 8 vane, open, semi-vortex.

Hytrel® thermoplastic elastomer.

Shaft: 410 series stainless steel.

Motor: dry type submersible motor, 1 & 3 phase, 115 & 230 volts, 60 Hz, 3500 RPM.

For continuous duty, with thermal protector IP68 in winding, insulation class B.



## FFBPEV512

Discharge: 2" NPT, female, vertical.

Spherical solids handling: 3/4"

HP: 0.5

RPM: 3500

Impeller: vortex, dynamically balanced.

Cast iron ASTM A-48, class 30. ISO G6.3

Shaft: 416 series stainless steel.

Motor: NEMA L, single phase, permanent split capacitor, 115 volts, 60 Hz, oil filled, with overload protection in motor.



## FFBPSTEP

Discharge: 2" NPT, vertical.

Spherical solids handling: 3/4"

HP: 0.5 & 1

RPM: 3500

Impeller: single vane enclosed.

Polypropylene with stainless steel insert.

Shaft: stainless steel.

Motor: NEMA L, single phase, permanent split capacitor, 115/230 volts, 60 Hz, oil filled, class B insulation, with overload protection in motor.



## FF2BEH-SS

Discharge: 2" NPT, vertical.

Spherical solids handling: 3/4"

HP: 0.5 & 1

RPM: 3500

Impeller: 2 vane, open, with vanes on back side, dynamically balanced ISO G6.3. Bronze 85-5-5-5.

Shaft: stainless steel.

Motor:

Single phase: NEMA L, permanent split capacitor, 115/230 volts, oil filled, with overload protection in motor.

Three phase: NEMA B, 208/230 & 460 volts, oil filled. Requires overload protection to be included in control panel.



## **FF2BSE411 & FF2BSE511**

Discharge: 2" NPT, vertical.  
Spherical solids handling: 2"  
HP: 0.4 & 0.5  
RPM: 1750  
Impeller: open, double vane, dynamically balanced.  
Cast iron ASTM A-48, class 30, ISO G6.3.  
Shaft: 416 series stainless steel.  
Motor: NEMA L, single phase, permanent split capacitor, 115 volts, 60 Hz, oil filled, with overload protection in motor.



## **FF2SEV512**

Discharge: 2" NPT, female, vertical.  
Spherical solids handling: 2"  
HP: 0.5  
RPM: 3500  
Impeller: vortex. Cast iron ASTM A-48, class 30, ISO G6.3.  
Shaft: 416 series stainless steel.  
Motor: NEMA L, single phase, permanent split capacitor, 115 volts, 60 Hz, oil filled, with overload protection in motor.



## **FF2BSE-SS / FF3BSE-SS**

Discharge: 2" or 3" NPT female, vertical, bolt on flange. Includes both flanges.  
(The name of the pump changes to FF3BSE when used with the 3" discharge flange.)  
Spherical solids handling: 2"  
HP: 0.5 & 0.75  
RPM: 1750  
Impeller: 2 vane, open, with vanes on back side.  
Cast iron ASTM A-48, class 30.  
Shaft: 416 series stainless steel.  
Motor: NEMA L, single phase, permanent split capacitor, 120 volts, 60 Hz, oil filled, with overload protection in motor.





## FF3BSE-SS / 1 HP

Discharge: 3" NPT, female, vertical, bolt on flange.  
Spherical solids handling: 2"

HP: 1

RPM: 1750

Impeller: 2 vane, open, with vanes on back side.

Cast iron ASTM A-48, class 30.

Shaft: 416 series stainless steel.

Motor:

Single phase: NEMA L, permanent split capacitor, 230 volts, 60 Hz, oil filled, with overload protection in motor.

Three phase: NEMA B, 230/460 volts, 60 Hz, oil filled. Requires overload protection to be included in control panel.



## FF3BSE-SS / 1.5 & 2 HP

Discharge: 3" NPT, female, vertical, bolt on flange.  
Spherical solids handling: 2½"

HP: 1.5 & 2

RPM: 1750

Impeller: 2 vane, open, with vanes on back side.

Cast iron ASTM A-48, class 30.

Shaft: 416 series stainless steel.

Motor:

Single phase: NEMA L, permanent split capacitor, 230 volts, 60 Hz, oil filled, with overload protection in motor.

Three phase: NEMA B, 230/460 volts, 60 Hz, oil filled. Requires overload protection to be included in control panel.



### **FF3BSE-SS / 3 HP**

Discharge: 3" NPT, female, vertical, bolt on flange.  
Spherical solids handling: 2½"

HP: 3

RPM: 1750

Impeller: 2 vane, open, with vanes on back side.

Cast iron ASTM A-48, class 30.

Shaft: 416 series stainless steel.

Motor:

Single phase: permanent split capacitor, 230 volts, 60 Hz, oil filled, with overload protection in motor.

Three phase: 230/460 volts, 60 Hz, oil filled.

Requires overload protection to be included in control panel.



### **FF3BWSE-DS**

Discharge: 3", 125 lb, flange horizontal.

Spherical solids handling: 2½"

HP: 2-5

RPM: 1750

Impeller: 2 vane, semi-open, with vanes on back side. Cast iron ASTM A-48, class 30.

Shaft: 416 series stainless steel.

Motor: NEMA B, three phase, 230 & 460 volts, 60 Hz, oil filled, with class F insulation.

Requires overload protection to be included in control panel.



### **FF4BSE-SS**

Discharge: 4" NPT vertical.

Spherical solids handling: 3"

HP: 3 & 5

RPM: 1750

Impeller: 2 vane, open, with vanes on back side.

Cast iron ASTM A-48, class 30.

Shaft: 416 series stainless steel.

Motor: NEMA B, three phase, 230/460 volts, 60 Hz, oil filled, with class F insulation.

Requires overload protection to be included in control panel.



## FF4BWSE-DS

Discharge: 4", 125 lb, flange horizontal.

Spherical solids handling: 3"

HP: 2-7.5

RPM: 1750

Impeller: 2 vane, open, with vanes on back side.

Cast iron ASTM A-48, class 30.

Shaft: 316 series stainless steel.

Motor: NEMA B, three phase, 230 & 460 volts, 60 Hz, oil filled, with class F insulation.

Requires overload protection to be included in control panel.



## FF4BSE-DS

Discharge: 4", 125 lb, flange horizontal.

Spherical solids handling: 3"

HP: 4.5-15

RPM: 1750

Impeller: 2 vane, open, with vanes on back side.

Cast iron ASTM A-48, class 30.

Shaft: 416 series stainless steel.

Motor:

Single phase: NEMA L, permanent split capacitor, 230 volts, 60 Hz, oil filled.

Three phase: NEMA B 230/460 volts, 60 Hz, oil filled.



## FF4BSE-HLDS

Discharge: 4", 125 lb, flange horizontal.

Spherical solids handling: 3"

HP: 7.5-15

RPM: 1750

Impeller: 2 vane, closed, with vanes on back side.

Cast iron ASTM A-48, class 30.

Shaft: 416 series stainless steel.

Motor: NEMA B, three phase, 230/460 volts, 60 Hz, oil filled. Requires overload protection to be included in control panel.





### **FF6BSE-LDS / 9-30 HP**

Discharge: 6", 125 lb, flange horizontal.  
Spherical solids handling: 4"  
HP: 9-30  
RPM: 1150  
Impeller: 1 vane, closed, with vanes on back side.  
Cast iron ASTM A-48, class 30.  
Shaft: 416 series stainless steel.  
Motor: NEMA B, three phase, 230/460 volts, 60 Hz, oil filled. Requires overload protection to be included in control panel.



### **FF6BSE-LDS / 18-60 HP**

Discharge: 6", 125 lb, flange horizontal.  
Spherical solids handling: 4"  
HP: 18-60  
RPM: 1750  
Impeller: 1 vane (2 vane for 48 & 60 HP), closed, with vanes on back side. Cast iron ASTM A-48, class 30.  
Shaft: 416 series stainless steel.  
Motor: NEMA B, three phase, 230/460 volts, 60 Hz, oil filled. Requires overload protection to be included in control panel.



### **FF6BSE-HLDS**

Discharge: 6", 125 lb, flange horizontal.  
Spherical solids handling: 3"  
HP: 30-60  
RPM: 1750  
Impeller: 3 vane, closed, with vanes on back side.  
Cast iron ASTM A-48, class 30.  
Shaft: 416 series stainless steel.  
Motor: NEMA B, three phase, 230/460 volts, 60 Hz, oil filled. Requires overload protection to be included in control panel.



## FF8BSE-HLDS

Discharge: 8", 125 lb, flange horizontal.

Spherical solids handling: 3"

HP: 36-48

RPM: 1150

Impeller: 3 vanes, closed, with a bronze wear ring and vanes on back side. Cast iron ASTM A-48, class 30.

Shaft: 416 series stainless steel.

Motor: NEMA B, three phase, 230/460 volts, 60 Hz, oil filled. Requires overload protection to be included in control panel.

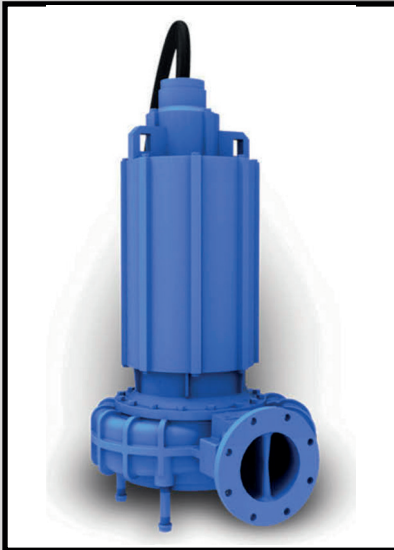

## FF8BSE-HADS

Discharge: 8", 125 lb, flange horizontal.

Spherical solids handling: 3"

HP: 30-75 / 100-200

RPM: 1150 / 3450

Impeller: 3 vane, closed, with with a bronze wear ring and vanes on back side. Cast iron ASTM A-48, class 30.

Shaft: 416 series stainless steel.

Motor: NEMA B, three phase, 230/460 volts, 60 Hz, air cooled. Explosion proof, class 1, division 1, group C & D. Requires overload protection to be included in control panel.



### **FF4XBSE W/ EXPLOSION PROOF MOTORS**

Discharge: 4", 125 lb, flange horizontal.  
Spherical solids handling: 3"  
HP: 5-20  
RPM: 1150 & 1750  
Impeller: 2 vane, open, with vanes on back side.  
Cast iron ASTM A-48 class 30.  
Shaft: 416 series stainless steel.  
Motor: NEMA B, three phase, 230 & 460 volts, 60 Hz, 1150 & 1750 RPM, air cooled. Explosion Proof, Class 1, Division 1, Group C & D, insulation Class F. Requires overload protection to be included in control panel.



### **FF6XBSE W/ EXPLOSION PROOF MOTORS**

Discharge: 6", 125 lb, flange horizontal.  
Spherical solids handling: 4"  
HP: 15-75  
RPM: 1150 & 1750  
Impeller: 1 vane, closed, with vanes on back side.  
Cast iron ASTM A-48 class 30.  
Shaft: 416 series stainless steel.  
Motor: NEMA B, three phase, 230 & 460 volts, 60 Hz, 1150 & 1750 RPM, air cooled. Explosion Proof, Class 1, Division 1, Group C & D, insulation Class F. Requires overload protection to be included in control panel.



### **FF8XBSE W/ EXPLOSION PROOF MOTORS**

Discharge: 8", 125 lb, flange horizontal.  
Spherical solids handling: 3"  
HP: 30-150  
RPM: 1150 & 1750  
Impeller: 3 vane, closed, with with a bronze wear ring and vanes on back side. Cast iron ASTM A-48, class 30.  
Shaft: 416 series stainless steel.  
Motor: NEMA B, three phase, 460 volts, 60 Hz, 1150 & 1750 RPM, air cooled. Explosion Proof, Class 1, Division 1, Group C & D, insulation Class F. Requires overload protection to be included in control panel.





## FFBGP-DS / 2 HP

Discharge: 1¼" NPT, vertical.

HP: 2

RPM: 3500

Impeller: 12 vanes, vortex with vanes on back side, dynamically balanced. Cast iron ASTM A-48, class 30.

Radial cutter and shredding ring: hardened 440C, stainless steel, hardness Rockwell C-55.

Shaft: 420 series stainless steel.

Motor:

Single phase: permanent split capacitor, 220 volts, 60 Hz, oil filled, with overload protection in motor. Class F insulation.

Three phase: 220/440 volts, 60 Hz, oil filled with overload protection in motor. Class F insulation.



## FFBGP-DS / 3, 5 & 7.5 HP

Discharge: 2" NPT, vertical.

HP: 3, 5 & 7.5

RPM: 3500

Impeller: 10 vanes, vortex with vanes on back side, dynamically balanced. Cast iron ASTM A-48, class 30.

Radial cutter and shredding ring: hardened 440C, stainless steel, hardness Rockwell C-55.

Shaft: 420 series stainless steel.

Motor:

Single phase: NEMA L, permanent split capacitor (to be located in control panel), 230 volts, 60 Hz, oil filled. Class F insulation.

Three phase: NEMA B, 230/460 volts, 60 Hz, oil filled. Class F insulation. Requires overload protection to be included in control panel.



## FFBGPH-DS / 3, 5 & 7.5 HP

Discharge: 2½" flange, horizontal.

HP: 3, 5 & 7.5

RPM: 3500

Impeller: 10 vanes, vortex with vanes on back side, dynamically balanced. Cast iron ASTM A-48, class 30.

Radial cutter and shredding ring: hardened 440C, stainless steel, hardness Rockwell C-55.

Shaft: 420 series stainless steel.

Motor:

Single phase: NEMA L, permanent split capacitor (to be located in control panel), 230 volts, 60 Hz, oil filled. Class F insulation.

Three phase: NEMA B, 230/460 volts, 60 Hz, oil filled. Class F insulation. Requires overload protection to be included in control panel.



## FFBVRI

Discharge: 2" & 3" NPT elbow, vertical.

Spherical solids handling: 1½" & 2"

HP: 0.5 - 7.5

RPM: 3500

Impeller: 8 vane, semi-open Vortex. 316 series stainless steel.

Shaft: 416 series stainless steel.

Motor: For continuous duty, 1 & 3 phase, 3450 RPM, dry type, insulation class B, protection IP68, 115/230 volts.



## FFBVRI

Discharge: 2.5" & 3" NPT elbow, vertical.

Spherical solids handling: 2½" & 3"

HP: 1.5 - 3

RPM: 3450

Impeller: 6 & 8 vane, semi-open Vortex.

Cast iron ASTM A-48, class 30.

Shaft: 410 series stainless steel.

Motor: 1 & 3 phase, 230 volts, 60 Hz, 3450 RPM. For continuous duty, with protection IP68 in winding, insulation class B.

## FFMCN-G CHEMICAL PROCESS PUMP

### TECH DATA

- Size: 1" - 10"
- Max head: 6164GPM
- Max cap: 466'
- Media temp: -13°F ~+ 284°F
- Max System Pressure: 363PSI

### ADVANTAGE

- Complies with ANSI B73.1
- Open impeller
- High efficiency & energy saving
- Wide operation range
- Robust structure
- Modern design

### APPLICATION

- Chemical Engineering
- Paper and pulp
- All process industries
- Petrochemical

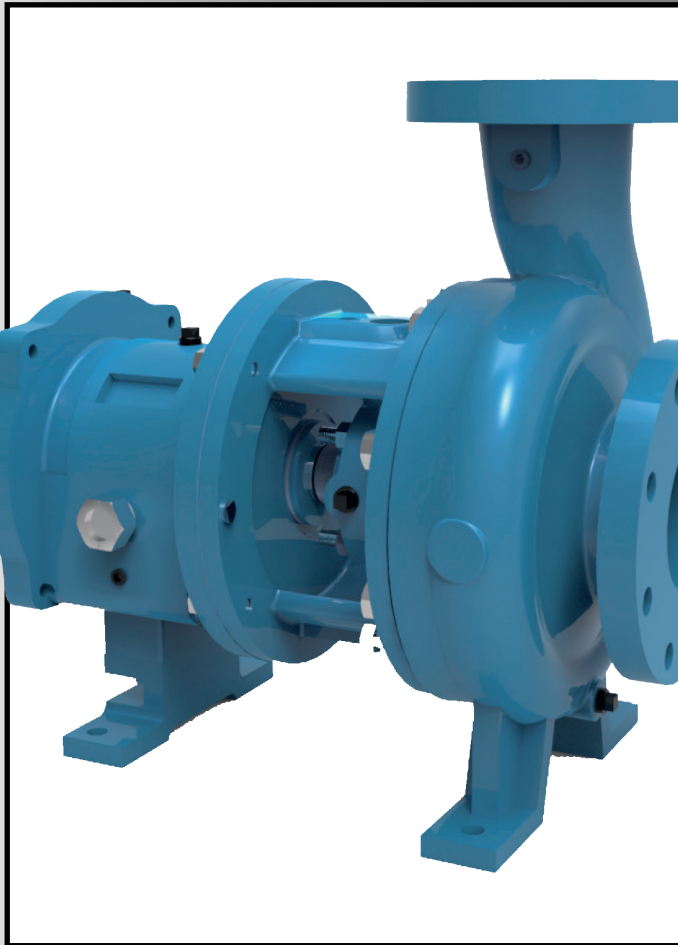

## FFMCO SLURRY PUMP

### TECH DATA

- Size: 2" - 12"
- Max cap: 7045GPM
- Max head: 361' '
- Media temp: -13°F ~+ 284°F
- Max system pressure: 232PSI

### ADVANTAGE

- Semi-open impeller
- Robust design
- Wide operation range
- Heavy duty bearing housing

### APPLICATION

- Barite & mineral oil based drilling
- Bentonite, Salt water slurry
- Cement
- Paper and pulp, Mine dewatering
- Lime, Gypsum, Calcium,
- Ash & coal liquid slurry
- Chemical industry

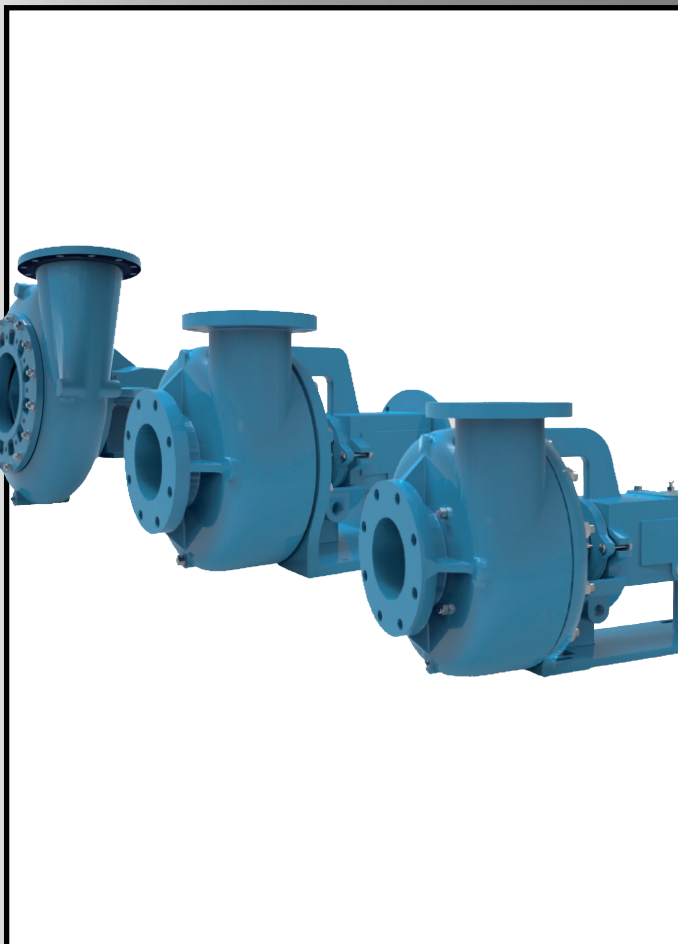



## FFMCT SELF PRIMING TRASH PUMP

### TECH DATA

- Size: 2"- 12"
- Max cap: 3400GPM
- Max head: 130'
- Media temp: 14°F ~+ 185°F
- Max system pressure: 51PSI
- Max suction: 25'
- Max solids: 3"

### ADVANTAGE

- Proven design
- Excellent performance
- Non-clogging design
- Excellent self priming function
- Installation and maintenance

### APPLICATION

- Municipal
- Marine
- Industrial sewage water treatment
- Agriculture irrigation
- Drainage/Construction



## FFMCST SELF PRIMING TRASH PUMP

### TECH DATA

- Size: 2"- 12"
- Max cap: 3400GPM
- Max head: 130'
- Media temp: 14°F ~+ 185°F
- Max system pressure: 51PSI
- Max suction: 25'
- Max solids: 3"

### ADVANTAGE

- Proven design
- Excellent performance
- Non-clogging design
- Excellent self priming function
- Installation and maintenance

### APPLICATION

- Municipal
- Marine
- Industrial sewage water treatment
- Agriculture irrigation
- Drainage/Construction



**FFMCU** HIGH HEAD SELF PRIMING TRASH PUMP

**TECH DATA**

- Size: 3" - 6"
- Max cap: 1500GPM
- Max head: 207'
- Media temp: 14°F ~+ 185°F
- Max system pressure: 87PSI
- Max suction: 25'
- Max solids: 1.25"

**ADVANTAGE**

- Proven design
- Excellent & reliable performance
- Non- clogging design
- Excellent self priming function
- Installation and maintenance
- Excellent trash handling capability

**APPLICATION**

- Municipal
- Marine
- Industrial sewage water treatment
- Agriculture irrigation

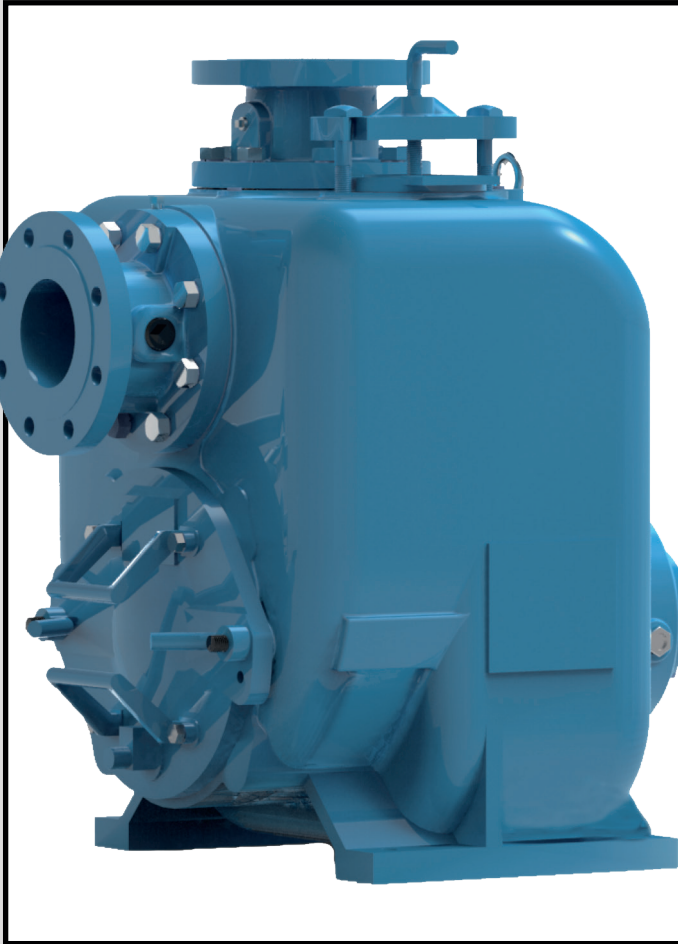

**FFMCSU** HIGH HEAD SELF PRIMING TRASH PUMP

**TECH DATA**

- Size: 3" - 6"
- Max cap: 1500GPM
- Max head: 207'
- Media temp: 14°F ~+ 185°F
- Max system pressure: 87PSI
- Max suction: 25'
- Max solids: 1.25"

**ADVANTAGE**

- Proven design
- Excellent & reliable performance
- Non- clogging design
- Excellent self priming function
- Installation and maintenance
- Excellent trash handling capability

**APPLICATION**

- Municipal
- Marine
- Industrial sewage water treatment
- Agriculture irrigation



# Typical Mechanical Room

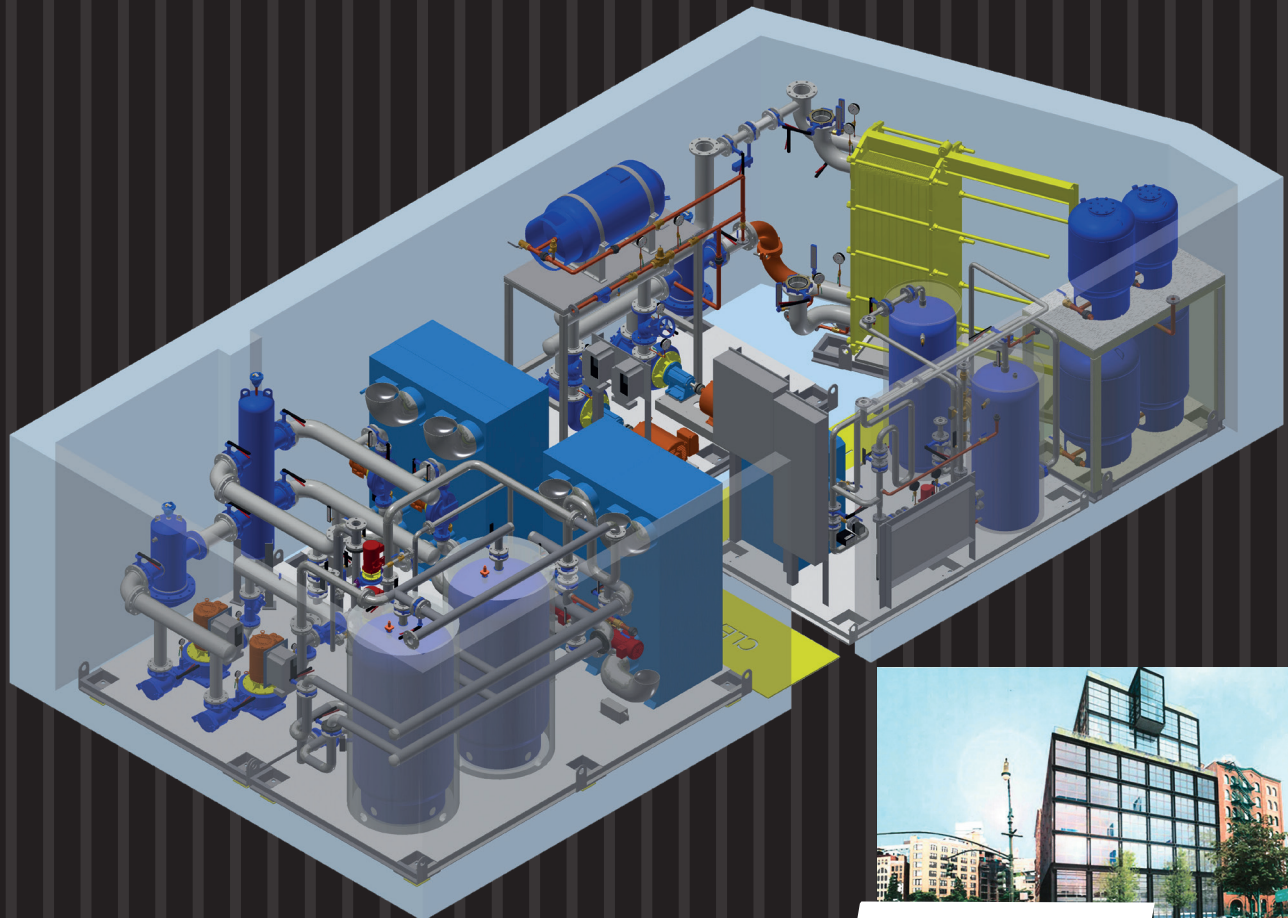
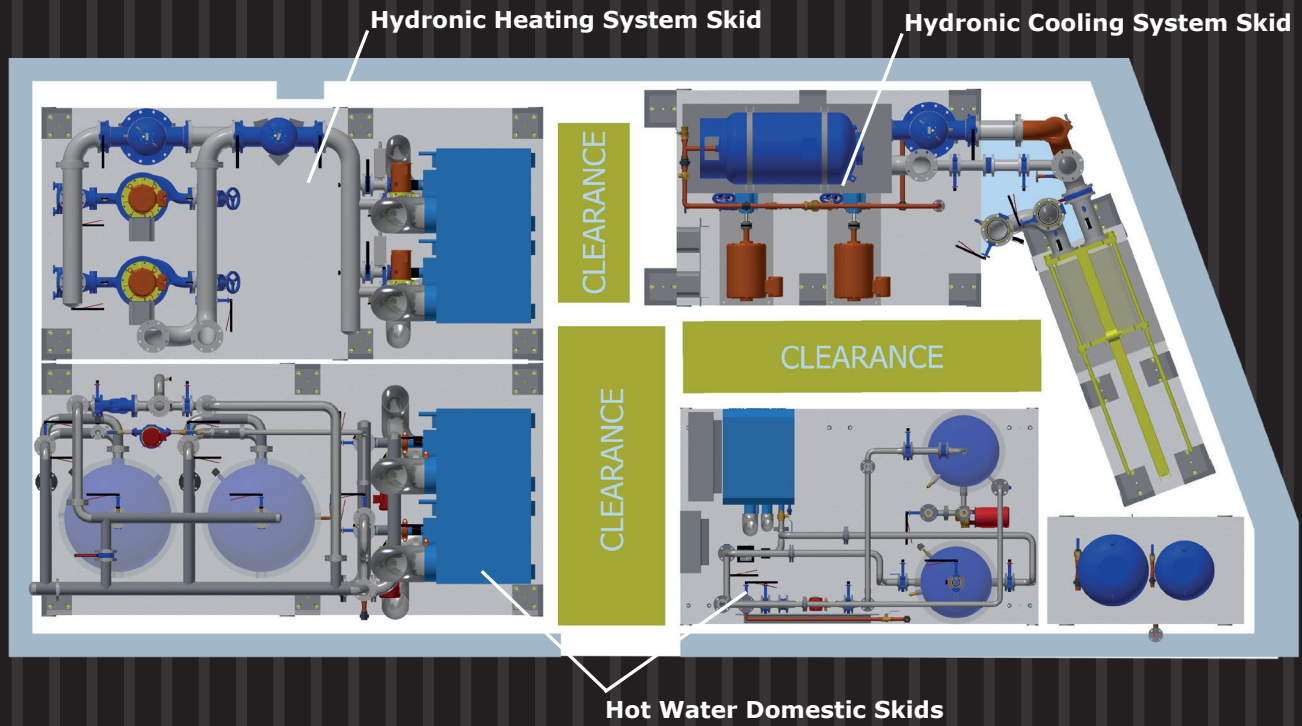

## FLEXIBLE - ST

Material: Steel and Stainless Steel  
 Pressure: 475 PSIG at 850°F with water  
 Size Range: 1/2" to 2"  
 Connections: Threaded



## AIR VENT - MV

Material: Cast Iron  
 Pressure: MV15 150 PSIG at 345°F  
 MV15 300 PSIG at 400°F  
 Size Range: 3/4"  
 Connections: Threaded



## PRESSURE AND OR TEMPERATURE PORTS

Material: Bronze  
 Pressure: 1000 PSIG at 140°F  
 Size Range: 1/4"  
 Connections: SS2501: Threaded  
 SS2511: Threaded Extended

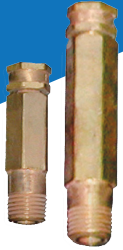

## UNION ARCH FLEXIBLE - DUT

Material: Steel Union and EPDM  
 Pressure: 214 PSIG at 250°F with water  
 Size Range: 1/2" to 12"  
 Connections: Threaded Double



## AIR VENT - AA

Material: Brass  
 Pressure: 150 PSIG at 200°F  
 Size Range: 1/8" and 1/4"  
 Connections: Threaded



## WAFER CHECK VALVE - LSDDB

Material: Cast Iron Body, Stainless Steel Disc, EPDM Seat  
 Pressure: 175 PSIG at 225°F up to 12"  
 150 PSIG at 250°F from 14" to 24"  
 Size Range: 2" to 24"  
 Body Style: Wafer



## STANDARD FLANGED CONNECTOR - SM

Material: Steel and Stainless Steel  
 Pressure: 125 PSIG at 450°F with water  
 Size Range: 2" to 16"  
 Body Style: Flanged



## BUTTERFLY VALVE - BFVZ - L

Material: Cast Iron Body, Stainless Steel Disc, EPDM Seat  
 Pressure: 175 PSIG at 225°F up to 12"  
 150 PSIG at 250°F from 14" to 24"  
 Size Range: 2" to 24"  
 Body Style: Lug



## SUCTION DIFFUSER - ASDFF

Material: Cast Iron Body, Stainless Steel Screen  
 Pressure: 175 PSIG at 250°F with water  
 200 PSIG at 150°F with steam  
 Size Range: 2" to 20"  
 Connections: Flanged



## SINGLE ARCH FLEXIBLE - SSP & DSP

Material: Steel Flanged and EPDM  
 Pressure: 214 PSIG at 240°F with water  
 Size Range: 1 1/2" to 14"  
 Connections: SSP Flanged Single  
 DSP Flanged Double



## MULTIFUNCTION VALVE - MFV

Material: Ductile Iron and Stainless Steel Disc  
 Pressure: 150 PSIG at 225°F  
 Size Range: 2" to 18"  
 Connections: MFV-F: Flanged





## 2000 - FIXED BLADDER EXPANSION TANK

Capacities: 2 to 132 Gallons (8 to 528 liters)  
 Pressure: up to 150PSI (1034kpa)  
 Temperature: up to 200°F (93°C)  
 Materials: Carbon Steel, Butyl



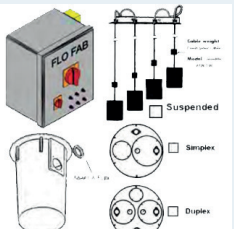

				
<b>SERIES</b>	<b>LB-25, 40, 75, 215 &amp; 315</b>	<b>FS-237, 337 &amp; 437, 475, 675, 4110, 6110, 8110</b>	<b>LBV-40</b>   <b>LBV-75, 215 &amp; 315</b>	<b>LBK-75</b>   <b>LBK-215 &amp; 315</b>
<b>TYPE</b>	Effluent Pump	Multi-Purpose Drainage Pump	Effluent & Sewage Vortex Pump	Effluent   Sewage Non Clog Pump
<b>CAPACITIES</b>	up to 175 USGPM (40 m <sup>3</sup> /hr)	up to 1400 USGPM (317 m <sup>3</sup> /hr)	up to 159 USGPM (36 m <sup>3</sup> /hr)	up to 185 USGPM (42 m <sup>3</sup> /hr)
<b>HEAD</b>	8 to 72 ft. (2.4 to 21.5 m)	10 to 163 ft. (3 to 49 m)	4 to 59 ft. (1.2 to 18m)	10 to 59 ft. (3 to 18m)
<b>SOLID SIZE</b>	3/8" (9 mm)	3/4" (19 mm)	3/4" (19mm)   2" (50mm)	3/4" (19mm)   2" (50mm)
<b>HORSEPOWER</b>	up to 1 HP (0.75 kW)	up to 30 HP (22 kW)	up to 1 HP (0.75 kW)	up to 1 HP (0.75 kW)
<b>DRIVES</b>	Air Filled Electrical Motors Explosion Proof	Air Filled Electrical Motors Explosion Proof	Air Filled Electrical Motors Explosion Proof	Air Filled Electrical Motors Explosion Proof
<b>APPLICATIONS</b>	Water	Water	Water, Sewage & Waste Liquids	Water   Water & Waste Liquids
<b>TEMPERATURE</b>	up to 200°F (94 °C)	up to 200°F (94 °C)	up to 200°F (94 °C)	up to 200°F (94 °C)
<b>CONSTRUCTION MATERIALS</b>	Cast Iron	Cast Iron and Stainless Steel	Cast Iron	Cast Iron

				
<b>SERIES</b>	<b>FBV-332</b>   <b>FBV-337 &amp; 437</b>	<b>FGC-015 / FGC-022</b>   <b>FGC-037 / FGC-055</b>	<b>BAF</b>	<b>Sub Accessories</b>
<b>TYPE</b>	Sewage Non Clog Pump	Sewage Grinder Pump	Break Away Fitting	
<b>CAPACITIES</b>	up to 317 USGPM 72 m <sup>3</sup> /hr	up to 61 USGPM 14 m <sup>3</sup> /hr		
<b>HEAD</b>	8 to 66ft (2.4 to 20 m)	17 to 105ft (5.2 to 32 m)		
<b>SOLID SIZE</b>	2" (50 mm)   3" (80 mm)	3/4" (19 mm)		
<b>HORSEPOWER</b>	up to 5 HP (3.7 kW)	up to 5 HP (3.7 kW)		
<b>DRIVES</b>	Air Filled Electrical Motors Explosion Proof	Air Filled Electrical Motor Explosion Proof		
<b>APPLICATIONS</b>	Water, Sewage & Waste Liquids	Water, Sewage & Waste Liquids		
<b>TEMPERATURE</b>	up to 200°F (94°C)	up to 200°F (94°C)		
<b>CONSTRUCTION MATERIAL</b>	Cast Iron	Cast Iron	Cast Iron	



<b>CAPACITIES</b>	up to 30 USGPM (3.1 m <sup>3</sup> /hr)
<b>HEAD</b>	up to 692 ft. (300 PSI) (211 m)
<b>PRESSURE</b>	up to 300 PSI (2069 kPa)
<b>HORSEPOWER</b>	up to 10 HP (7.46 kW)
<b>DRIVES</b>	Electrical Motors
<b>APPLICATIONS</b>	Light Fuel Oil
<b>TEMPERATURE</b>	up to 150°F (65°C)
<b>CONSTRUCTION MATERIAL</b>	Bronze / Stainless Steel or Cast Iron

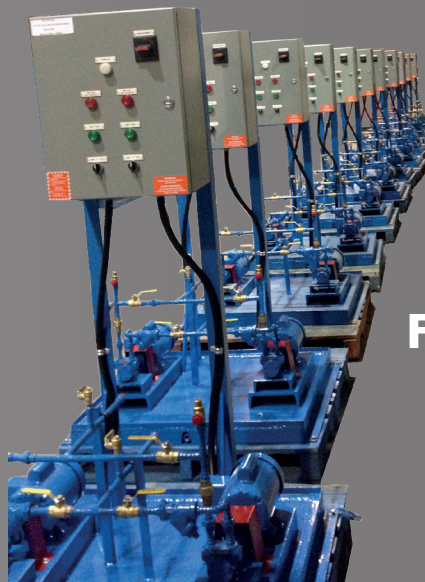

Type: D-FOM  
Duplex  
Fuel Oil System

<b>CAPACITIES</b>	up to 12000 USGPM (2725 m <sup>3</sup> /hr)
<b>HEAD</b>	up to 692 ft. (300 PSI) (211 m)
<b>PRESSURE</b>	up to 300 PSI (2069 kPa)
<b>HORSEPOWER</b>	up to 400 HP (298.3 kW)
<b>DRIVES</b>	Electrical Motors
<b>APPLICATIONS</b>	Water / Glycol
<b>TEMPERATURE</b>	up to 300°F (144°C)
<b>CONSTRUCTION MATERIAL</b>	Bronze / Stainless Steel or Cast Iron

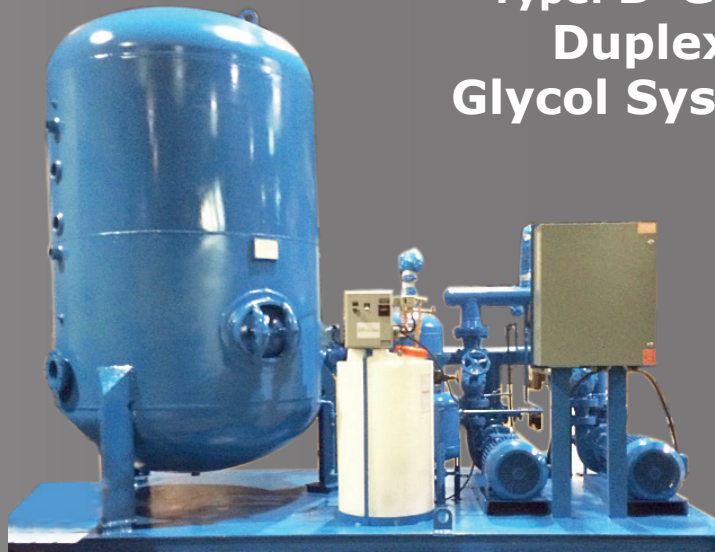

Type: D-GLY  
Duplex  
Glycol System

<b>CAPACITIES</b>	up to 12000 USGPM (2725 m <sup>3</sup> /hr)
<b>HEAD</b>	up to 692ft. (300 PSI) (211 m)
<b>PRESSURE</b>	up to 300 PSI (2069 kPa)
<b>HORSEPOWER</b>	up to 400 HP (298.3 kW)
<b>DRIVES</b>	Electrical Motors
<b>APPLICATIONS</b>	Water / Glycol
<b>TEMPERATURE</b>	up to 300°F (144°C)
<b>CONSTRUCTION MATERIAL</b>	Bronze / Stainless Steel or Cast Iron

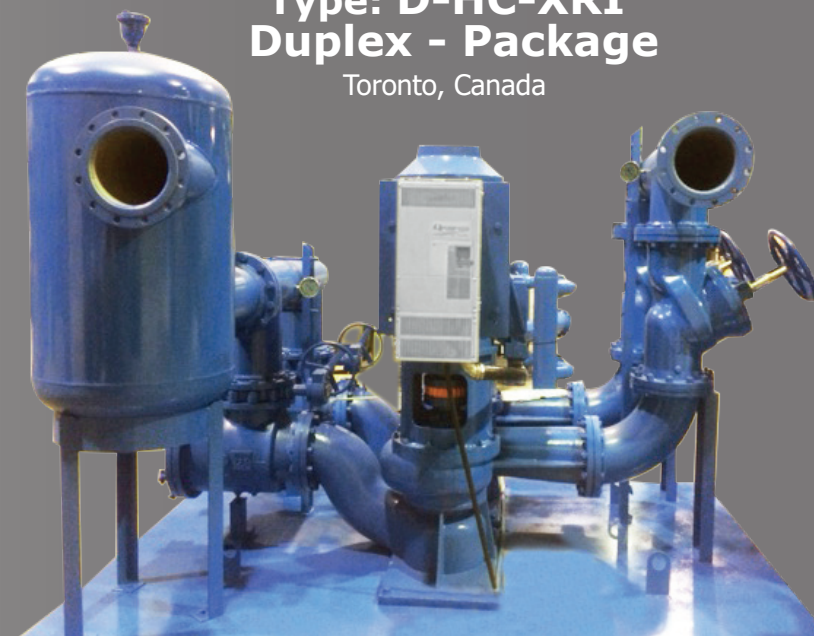

Type: D-HC-XRI  
Duplex - Package  
Toronto, Canada

<b>CAPACITIES</b>	up to 12000 USGPM (2725 m <sup>3</sup> /hr)
<b>HEAD</b>	up to 692 ft. (300 PSI) (211 m)
<b>PRESSURE</b>	up to 300 PSI (2069 kPa)
<b>HORSEPOWER</b>	up to 400 HP (298.3 kW)
<b>DRIVES</b>	Electrical Motors
<b>APPLICATIONS</b>	Water / Glycol
<b>TEMPERATURE</b>	up to 300°F (144°C)
<b>CONSTRUCTION MATERIAL</b>	Bronze / Stainless Steel or Cast Iron

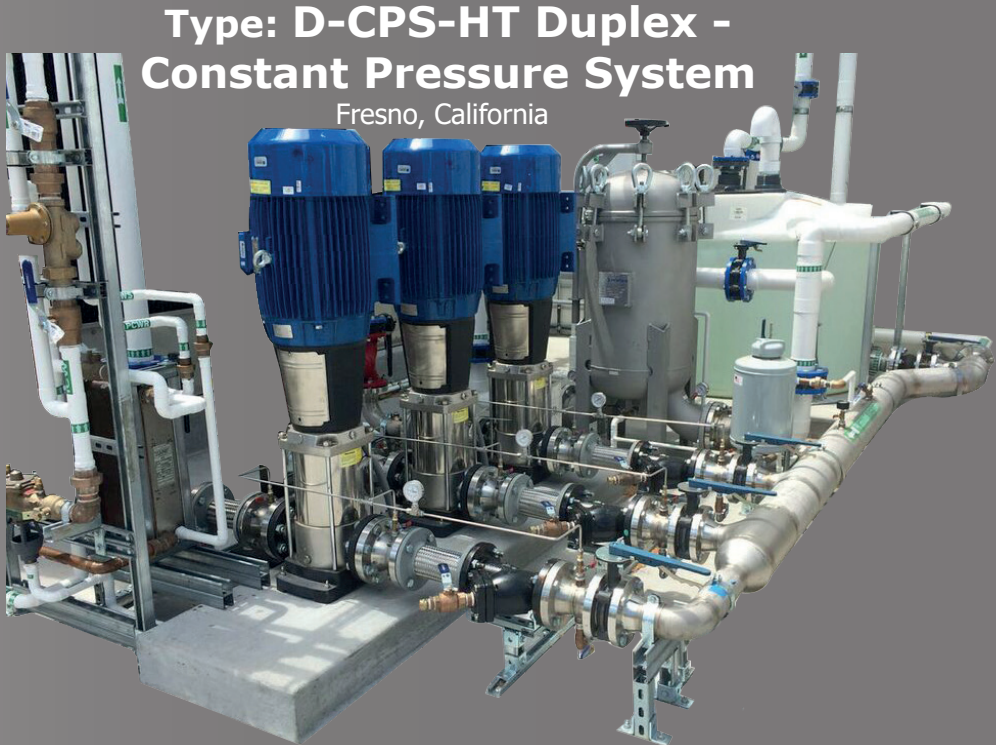

**Type: D-CPS-HT Duplex - Constant Pressure System**

Fresno, California

<b>CAPACITIES</b>	up to 12000 USGPM (2725 m <sup>3</sup> /hr)
<b>HEAD</b>	up to 692 ft. (300 PSI) (211 m)
<b>PRESSURE</b>	up to 300 PSI (2069 kPa)
<b>HORSEPOWER</b>	up to 400 HP (298.3 kW)
<b>DRIVES</b>	Electrical Motors
<b>APPLICATIONS</b>	Water / Glycol
<b>TEMPERATURE</b>	up to 300°F (144°C)
<b>CONSTRUCTION MATERIAL</b>	Bronze / Stainless Steel or Cast Iron



**Type: BOI Boiler Package**

San Francisco - California, USA

<b>CAPACITIES</b>	up to 12000 USGPM (2725 m <sup>3</sup> /hr)
<b>HEAD</b>	up to 692 ft. (300 PSI) (211 m)
<b>PRESSURE</b>	up to 300 PSI (2069 kPa)
<b>HORSEPOWER</b>	up to 400 HP (298.3 kW)
<b>DRIVES</b>	Electrical Motors
<b>APPLICATIONS</b>	Water / Glycol
<b>TEMPERATURE</b>	up to 300°F (144°C)
<b>CONSTRUCTION MATERIAL</b>	Bronze / Stainless Steel or Cast Iron



**Type: CHI Chiller Package**

Garden City - Texas, USA



<b>CAPACITIES</b>	up to 12000 USGPM (2725 m <sup>3</sup> /hr)
<b>HEAD</b>	up to 692 ft. (300 PSI) (211 m)
<b>PRESSURE</b>	up to 300 PSI (2069 kPa)
<b>HORSEPOWER</b>	up to 400 HP (298.3 kW)
<b>DRIVES</b>	Electrical Motors
<b>APPLICATIONS</b>	Water / Glycol
<b>TEMPERATURE</b>	up to 300°F (144°C)
<b>CONSTRUCTION MATERIAL</b>	Bronze / Stainless Steel or Cast Iron



**Type: LCOO  
Large Cooling  
Package**

Fort Bliss - Texas, USA

<b>CAPACITIES</b>	up to 12000 USGPM (2725 m <sup>3</sup> /hr)
<b>HEAD</b>	up to 692 ft. (300PSI) (211 m)
<b>PRESSURE</b>	up to 300 PSI (2069 kPa)
<b>HORSEPOWER</b>	up to 400 HP (298.3 kW)
<b>DRIVES</b>	Electrical Motors
<b>APPLICATIONS</b>	Water / Glycol
<b>TEMPERATURE</b>	up to 300°F (144°C)
<b>CONSTRUCTION MATERIAL</b>	Bronze / Stainless Steel or Cast Iron

**Type: HCE  
Heating  
Cooling with  
Enclosure**

Michigan, USA



# FLO FAB

## Booster

Parts and Labour  
Packages  
8  
Year warranty

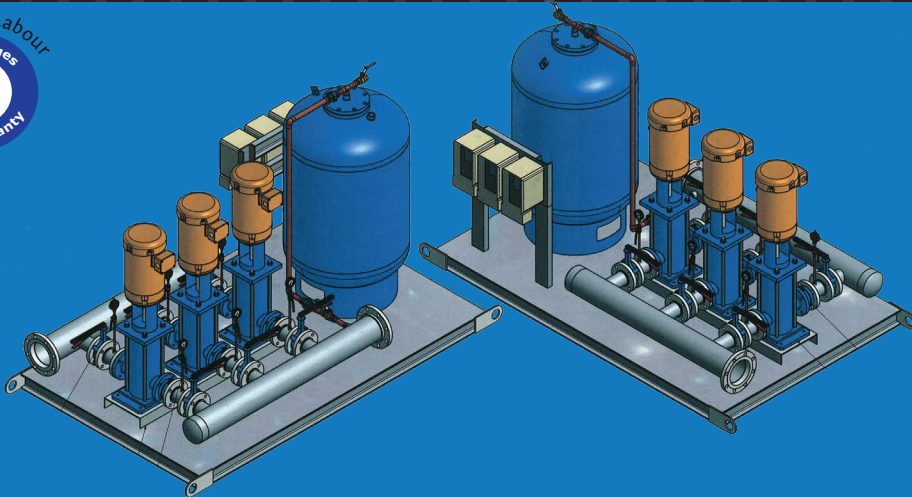

COGIR JAZZ ,  
LONGUEIL, MONTREAL,

## Heating or Cooling

Parts and Labour  
Packages  
8  
Year warranty

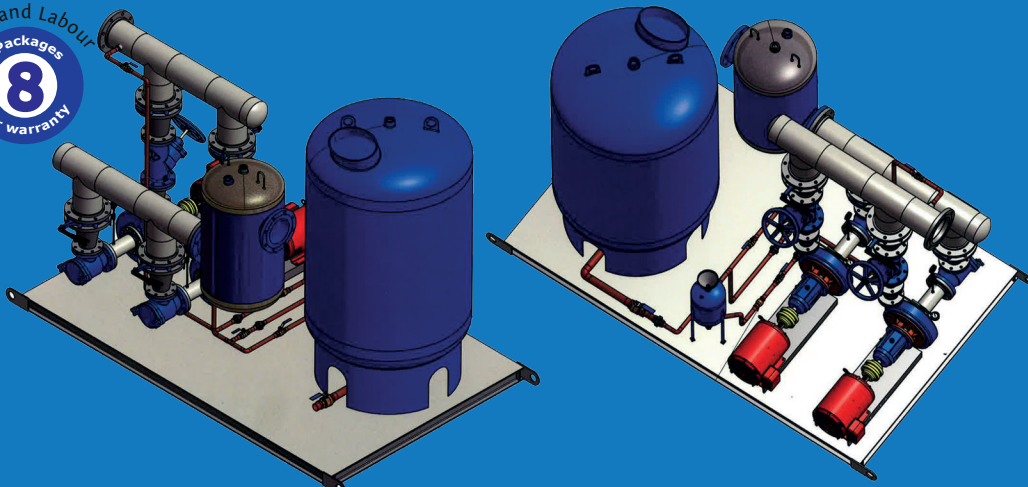

CONCORD GARDEN  
RICHMOND, B.C., CA

## Large Cooling

Parts and Labour  
Packages  
8  
Year warranty

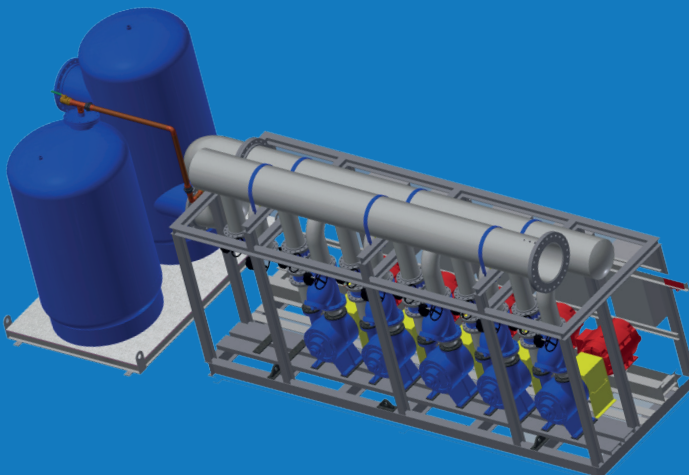

FORT BLISS HOSPITAL  
EL PASO, TEXAS,  
UNITED-STATES



# Proud pump supplier for the New World Trade Center towers in New York

AND MORE

## Heat Transfer

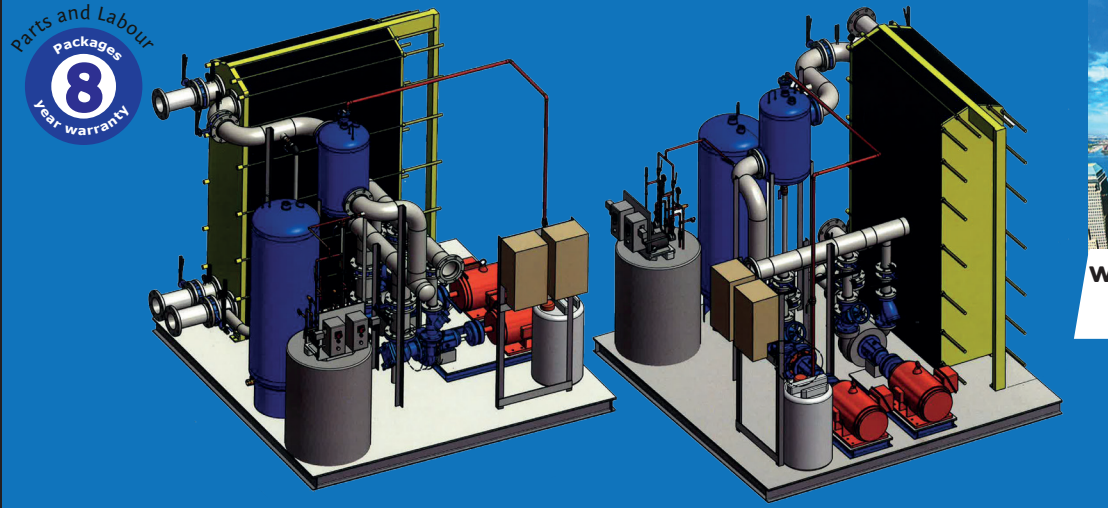

WORLD TRADE CENTER  
NEW-YORK, U.S.A.

## Duplex Pumps - Heating System

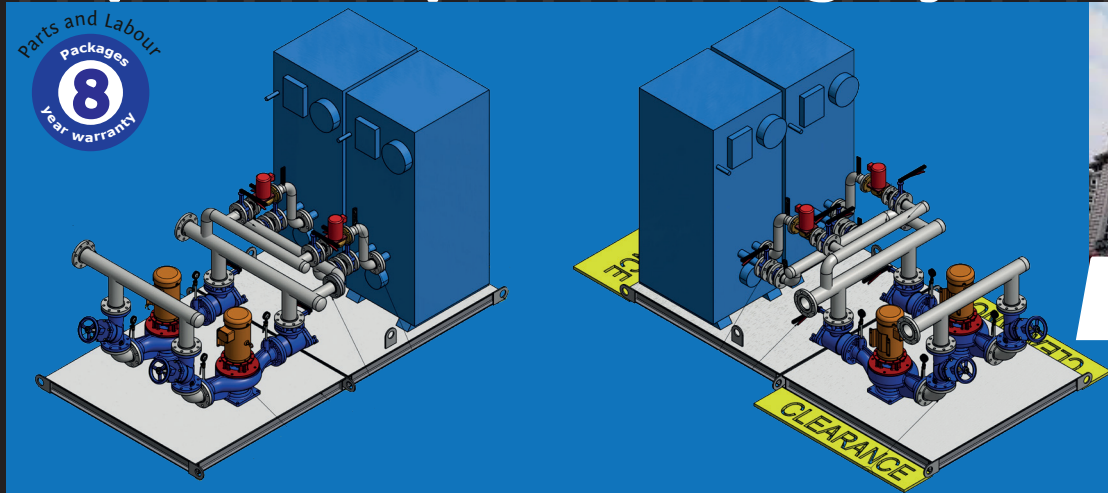

CRITERION HAGUE  
NEW-YORK, U.S.A.  
PHASE 1

## Boiler Pack

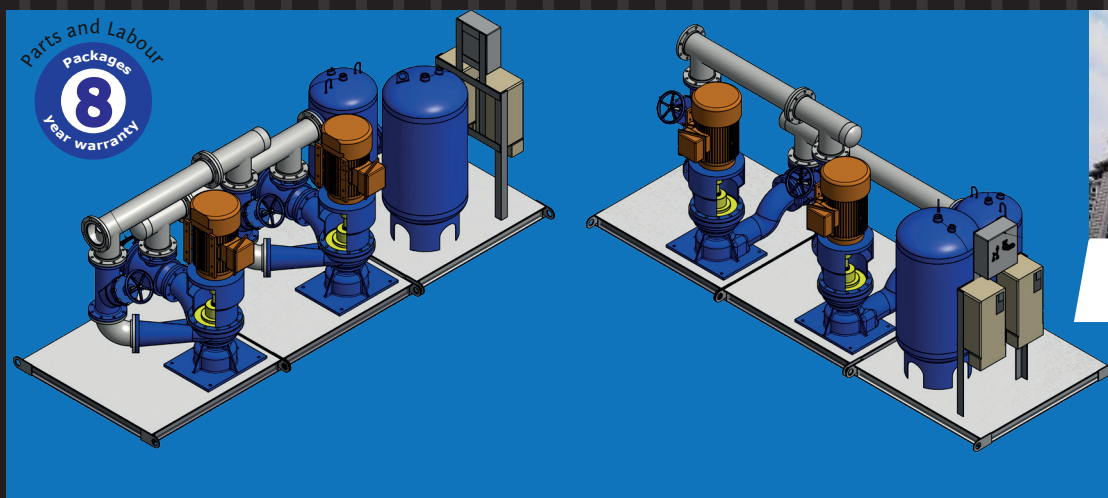

CRITERION  
NEW-YORK, U.S.A.  
PHASE 2



We are a proud supplier for the following completed and ongoing projects :



**Zermatt Lodge**

Salt Lake City, UT, U.S.A.  
<https://zermattresort.com>



**Pier 17 South Street Seaport**

South Street, New York, U.S.A  
[www.southstreetseaport.com](http://www.southstreetseaport.com)



**Pearl-Qatar**

Doha, Qatar  
[www.thepearlqatar.com](http://www.thepearlqatar.com)



**Museum of Science and Industry**

Tampa, Florida  
[www.mosi.org](http://www.mosi.org)

Eng : Advance System Engineering



**Exchange Tower**

Vancouver, B.C., Canada  
[www.theexchangebuilding.ca](http://www.theexchangebuilding.ca)



**Dar El Salam General Hospital**

Cairo Governorate, Egypt

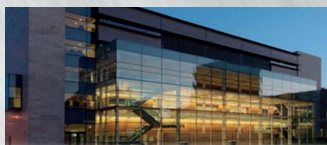

**Brock University Center**

St. Catharines, Ontario, Canada  
<https://www.brocku.ca>



**520 Park Avenue**

New York, U.S.A  
[www.520parkavenue.com](http://www.520parkavenue.com)

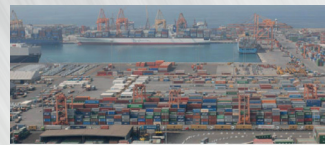

**Saudi Jeddah Port**

Jeddah Saudi, Arabia  
[www.ports.gov.sa](http://www.ports.gov.sa)



**St-Joseph Women's Hospital**

Tampa, Florida  
[www.sjbhealth.org](http://www.sjbhealth.org)

Eng : Smith, Seckman,  
 Reid Engineering



**Millennium Hilton**

New-York City, NY, U.S.A  
[www.hilton.com](http://www.hilton.com)



**Le M Lorraine**

Lorraine, Quebec, Canada  
[www.lemlorraine.com](http://www.lemlorraine.com)



**Morton Plant North Bay Hospital**

New Port Richey, Florida  
[www.mortonplant.com](http://www.mortonplant.com)

Eng : IC Thomasson  
 Association Incorporated



**Lowney**

Montréal, Quebec, Canada  
<http://lelowney.prevel.ca>

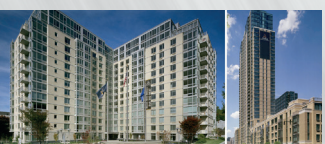

**Sheepshead Residential Tower**

Brooklyn, New York City, U.S.A.  
<http://www.sheepsheadbites.com>

# Sales and Service:

Quebec, Canada  
 Tel. : 450 621-2995  
 Fax : 450 621-4995

Lake Worth  
 Florida, USA  
 33467-5749

Toronto, Canada  
 Tel. : 1 647 544-2995

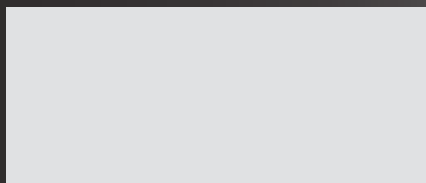

[www.flofab.com](http://www.flofab.com)

SERVICE 24/7 : [parts@flofab.com](mailto:parts@flofab.com)

