



Installation, Operation & Maintenance Manual

End Suction Centrifugal Pumps

1000/1004-IC1¼ SERIES

1 - 7.5 HP @ 3500 RPM



IMPORTANT! - Read all instructions in this manual before operating or servicing a pump.

Before installation, read the following instructions carefully. Failure to follow instruction and safety information could cause serious bodily injury, death and/or property damage. Each Flo Fab product is carefully inspected to insure proper performance. Closely following these instructions will eliminate potential operating problems, assuring years of trouble-free service.

⚠ DANGER Indicates an imminently hazardous situation which, if not avoided, WILL result in death or serious injury.

⚠ WARNING Indicates an imminently hazardous situation which, if not avoided, MAY result in death or serious injury.

⚠ CAUTION Indicates a potentially hazardous situation which, if not avoided, MAY result in minor or moderate injury.

IMPORTANT! - Flo Fab Pumps is not responsible for losses, injury or death resulting from failure to observe these safety precautions, misuse, abuse or misapplication of pumps or equipment.

ALL RETURNED PRODUCTS MUST BE CLEANED, SANITIZED, OR DECONTAMINATED PRIOR TO SHIPMENT, TO INSURE EMPLOYEES WILL NOT BE EXPOSED TO HEALTH HAZARDS IN HANDLING SAID MATERIAL. ALL APPLICABLE LAWS AND REGULATIONS SHALL APPLY.

⚠ WARNING Installation, wiring, and junction connections must be in accordance with the National Electric Code and all applicable state and local codes. Requirements may vary depending on usage and location.

⚠ WARNING Installation and servicing is to be conducted by qualified personnel only.

 Keep clear of suction and discharge openings. Do not insert fingers in pump with power connected; the impeller can cause serious injury.

 Always wear eye protection when working on pumps. Do not wear loose clothing that may become entangled in moving parts.

⚠ DANGER Pumps build up heat and pressure during operation. Allow time for pumps to cool before handling or servicing the pump or any accessory items associated with or near the pump. Do not block or restrict the discharge pipe/hose.

⚠ WARNING Do not pump hazardous materials (flammable, caustic, etc.) or use these pumps in water over 160 °F. Do not exceed manufacturers recommended maximum performance, as this could cause the motor to overheat.

⚠ DANGER This pump is not intended for use in swimming pools or water installations where there is human contact with pumped fluid.

⚠ DANGER Risk of electric shock. To reduce risk of electric shock, always disconnect pump from power source before handling any aspect of the pumping system. **Lock out power and tag.**

⚠ DANGER Do not lift, carry or hang pump by the electrical cables. Damage to the electrical cables can cause shock, burns or death. **Never** handle connected power cords with wet hands. Use appropriate lifting device.

⚠ DANGER Failure to permanently ground the pump, motor and controls before connecting to power can cause shock, burns or death.

⚠ WARNING Carefully read instruction manuals supplied with motor or engine before operating or servicing.

IMPORTANT! - Prior to installation, record Model Number, Serial, Amps, Voltage, Phase and HP from pump name plate for the future reference. Also record the Voltage and Current Readings at Startup:

1 Phase Models	
Amps:	Volts:
3 Phase Models	
Amps L1-2:	Volts L1-2:
Amps L2-3:	Volts L2-3:
Amps L3-1:	Volts L3-1:

Model Number: _____

Serial: _____

Phase: _____ HP: _____

- SUCTION:** 1½" NPT horizontal.
- DISCHARGE:** 1¼" NPT vertical.
- LIQUID TEMPERATURE:** 160°F (71 °C) max.
- VOLUTE:** Cast iron ASTM A-48 class 30.
- INTERMEDIATE COUPLING:** Cast iron ASTM A-48 class 30.
- IMPELLER:** 5 vanes, closed, statically balanced. Cast iron ASTM A-48 class 30.
- SEAL:** Mechanical, type 01. Ceramic stationary part, carbon ring seal and exclusion in the rotating part. Buna-N elastomer and stainless steel spring.
- SHAFT SLEEVE:** Stainless steel.
- O-RINGS:** Buna-N.
- MOTOR:** High quality premium efficiency TEFC or ODP electric motors, 1 & 3 phases, 60 Hz, NEMA, with rated output from 1 to 7.5 HP, 3500 RPM.
- PAINT:** Air dry enamel, water based.

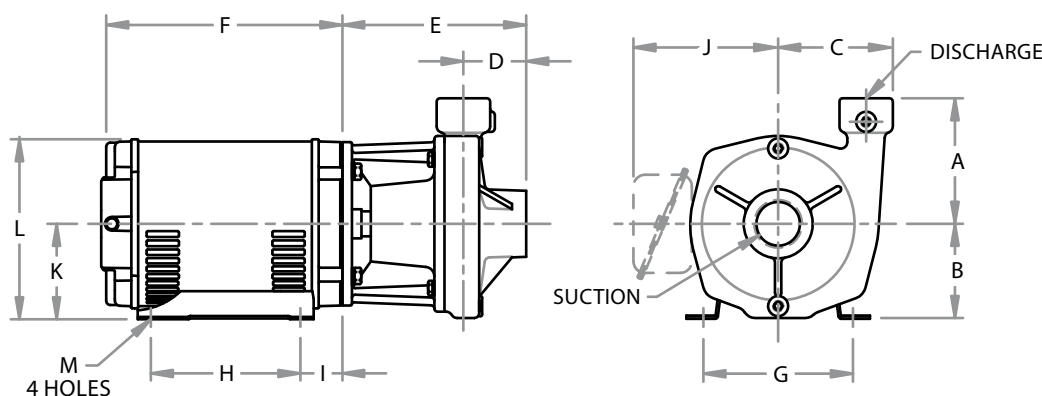

MODEL	PART No.	SIZE	HP	PHASE	ENCL.	FRAME	A	B	C	D	E	F	G	H	I	J	K	L	M														
1000/1004-IC1¼-1-2	62070501	1½" x 1¼"	1	3	ODP	56 J	5	3.75	3.5	2.5	5.5	9.31	4.88	3	2.75	-	3.5	6.75	0.34														
1000/1004-IC1¼-1-2-1	62070502		56 J	10.31																													
1000/1004-IC1¼-1.5-2	62070503		56 J	9.31																													
1000/1004-IC1¼-1.5-2-1	62070504		56 J	10.31																													
1000/1004-IC1¼-2-2	62070505		145 JM	12		5.5						5																					
1000/1004-IC1¼-2-2-1	62070506		145 JM	7.31		11.81						7.5								4.5	3.63	6.88	4.5	8.5	0.41								
1000/1004-IC1¼-3-2	62070507		182 JM																														
1000/1004-IC1¼-3-2-1	62070508		182 JM																														
1000/1004-IC1¼-5-2	-		-																							-	-	-	-	-	-	-	-
1000/1004-IC1¼-5-2-1	-		5	3		-						-								-	-	-	-	-	-	-	-	-	-	-	-	-	
1000/1004-IC1¼-7.5-2-1	-		7.5	1		-						-								-	-	-	-	-	-	-	-	-	-	-	-	-	
1000/1004-IC1¼-1-2	62070501		1½" x 1¼"	1		3						TEFC								-	-	-	-	-	-	-	-	-	-	-	-	-	-
1000/1004-IC1¼-1-2-1	62070502			-																													
1000/1004-IC1¼-1.5-2	62070503			-																													
1000/1004-IC1¼-1.5-2-1	62070504	-																															
1000/1004-IC1¼-2-2	62070505	-																															
1000/1004-IC1¼-2-2-1	62070506	-																															
1000/1004-IC1¼-3-2	62070507	-																															
1000/1004-IC1¼-3-2-1	62070508	-																															
1000/1004-IC1¼-5-2	-	-																															
1000/1004-IC1¼-5-2-1	-	-																															
1000/1004-IC1¼-7.5-2-1	-	-																															

All dimensions are in inches, and may vary depending on the motor manufacturer.

► Receiving inspection

Upon receiving the pump, it should be inspected for damage or shortages. If damage has occurred, file a claim immediately with the company that delivered the pump. If the manual is removed from the packaging, do not lose or misplace.

► Storage

Any product that is stored for a period longer than six (6) months from the date of purchase should be bench tested prior to installation. A bench test consists of, checking the impeller to assure it is free turning and a run test to assure the motor (and switch if provided) operate properly.

At any time exceeding six (6) months, but no more than twenty four (24), the equipment must be stored in a controlled area, keeping it away from contact with rain, dust, etc., and the temperature is maintained between 43-104 °F. If there is a possibility of high humidity (coastlines, etc.), the entire unit must be sprayed with antioxidant liquid.

► Service Stations

To find the nearest Barmesa Pumps authorized service shop, please directly contact your distributor or the factory.

► Installation

The pump should be as close as possible to the liquid to be pumped, with a minimum number of couplings, adapters, etc., in order to reduce friction on the suction side.

The suction and discharge piping must be perfectly aligned in the pump volute and supported independently using support or anchors, this to prevent excessive load on the volute.

The anchors of the motor are to be anchor, on a raised base, approximately 4", this to prevent accumulated water from entering the motor.

***See friction table in pipes and fittings to determine the dimensions of the suction and discharge. (Page 8)*

► Suction

Use pipe or hose reinforced sufficiently robust to prevent collapsing by the difference in atmospheric pressure. Check for leaks at all joints.

A successful operation depends on the calculation of the friction loss in the suction, considering acceptable limits. The minimum suction pipe size to use can be determined by comparing the NPSH available at the pump suction against the NPSH required by the impeller, as shown in the performance curves.

Usually, we recommend using a pipe diameter of 1/2" to 1" greater as that of the suction volute or body.

A strainer or sieve should be installed in the suction to prevent the entry of objects. The strainer must have a free entry area at least three times the pipe diameter. Usually a suction valve is combined with a strainer *Figure 1*.

Figure 1 Proper installation.

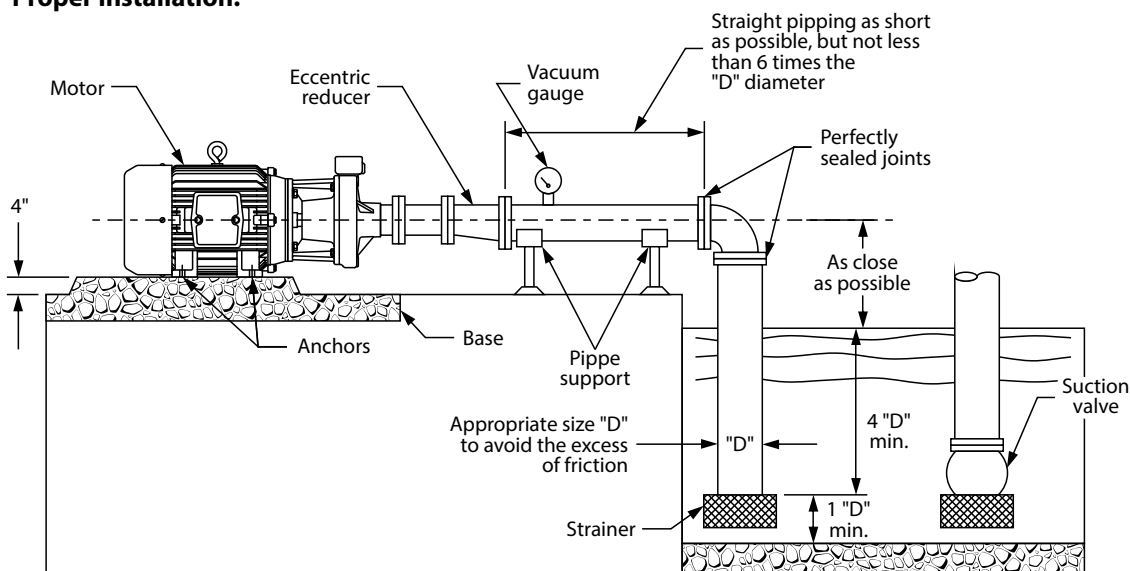

Figure 2 Wrong installation.

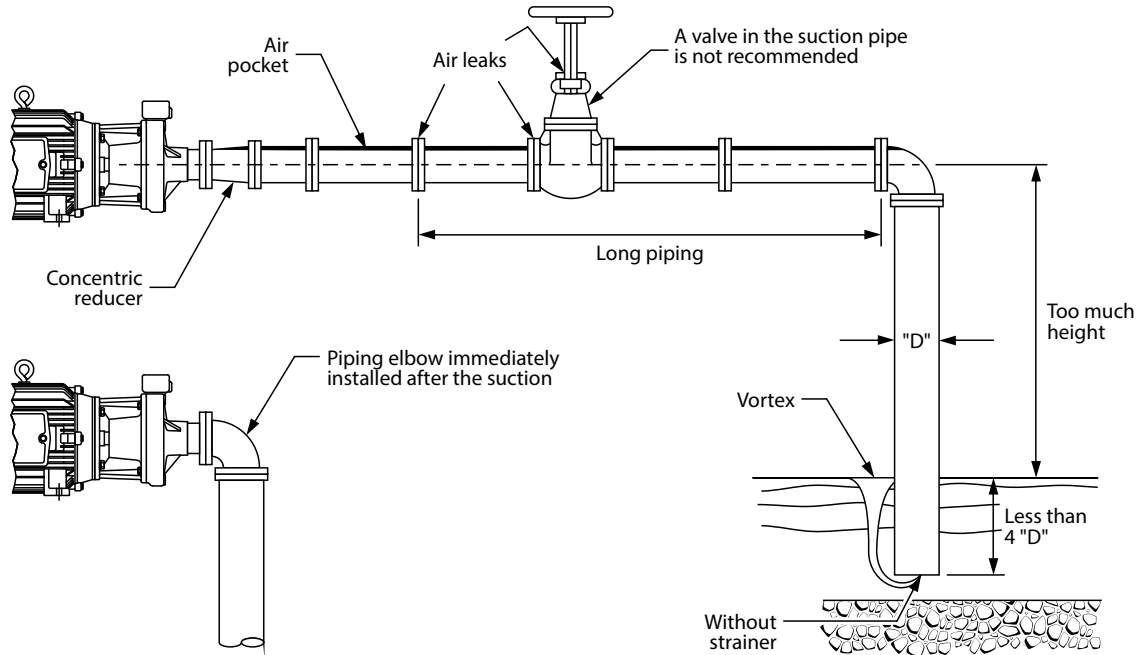
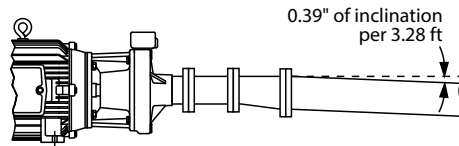

Figure 3 Inclination.
Correct

Suction height - suction pipe should have a slope of 0.39" per 3.3 ft of suction. Never exceed 16.4 ft suction, considering friction. (Figure 3)



Incorrect

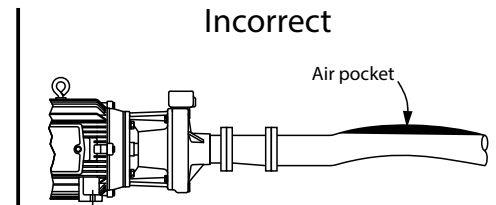
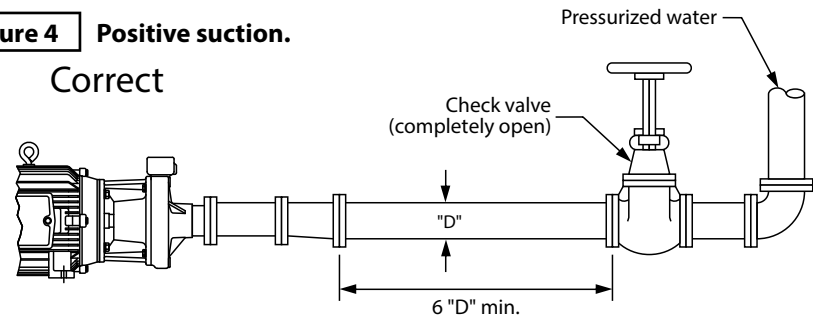

Figure 4 Positive suction.
Correct

Positive/Drowned Suction - A gate valve is installed in the suction pipe to service the pump (Figure 4). Volute or body have plugs, and these must be removed to allow trapped air to escape.



► **Discharge pipe**

Use pipe or hose reinforced sufficiently robust to prevent destruction due to high pressure.

Due to the cost of energy or BHP necessary to overcome the friction generated by using a smaller diameter pipe, a larger diameter discharge pipe is commonly used than the required by the volute or body.

Figure 5 Positive suction.

Incorrect

A retention valve in the suction pipe is not recommended. If required, better install the valve in the discharge pipe.

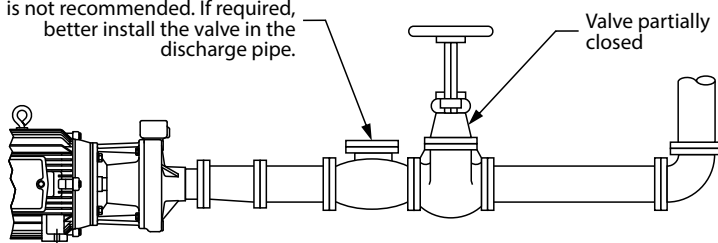
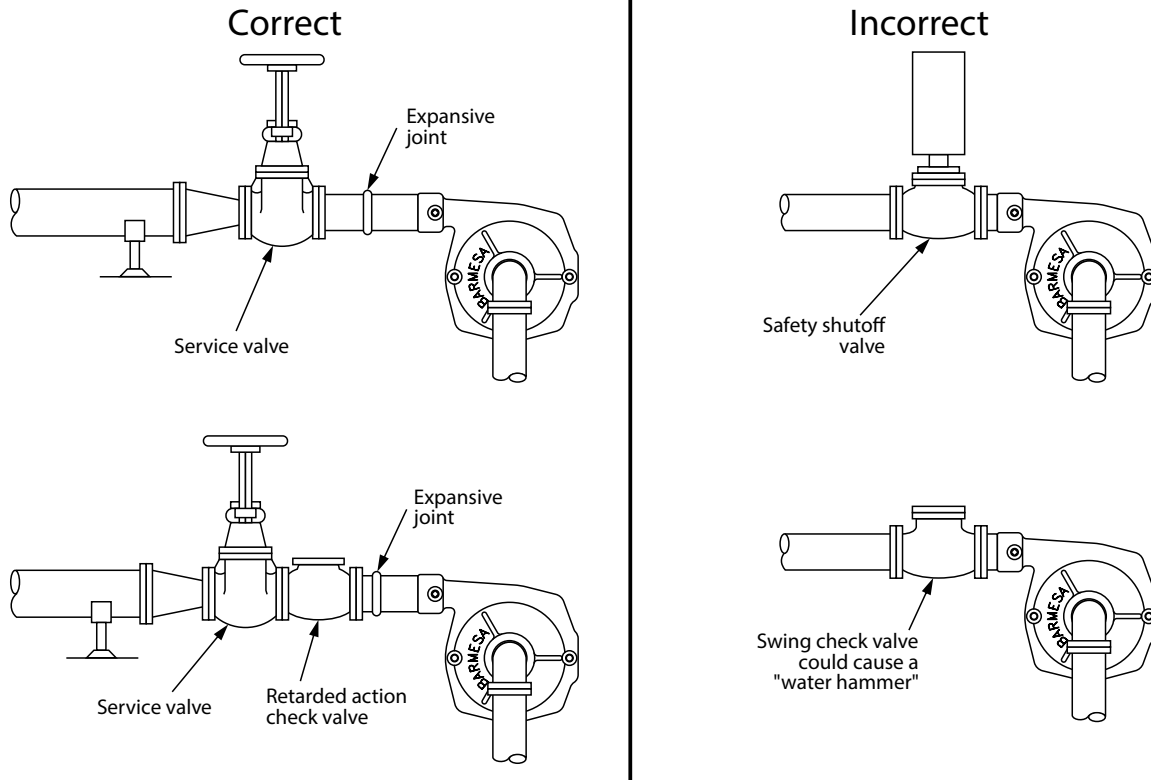

Figure 6 Discharge piping.



In order to determine the optimal size of the piping, compare the total cost of the equipment's operation (cost of the pump, control equipment, piping and energy consumption). By increasing the discharge diameter reasonably, it reduces the required BHP due to the low friction. Perform different tests using several piping diameters until you find the more convenient.

The pipe, valves, etc. should be perfectly align with the volutes suction and discharge centerlines, this to avoid any excessive loads on the pumps volute. If needed, install new expansive joints to protect the pump from excessive thermal or pressure forces.

► Pre-Operation

1. **Check Voltage and Phase** - Compare the voltage and phase information stamped on the pump name plate.

2. **Check Pump Rotation** - Improper motor rotation can result in poor pump performance and can damage the motor and/or pump. Check rotation on three phase units by momentarily applying power and observe the "kickback".

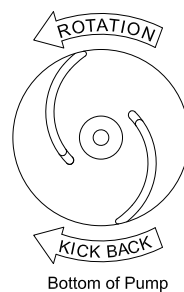

Kickback should always be in a counter-clockwise direction as viewed from motor end or opposite to impeller rotation. Impeller rotation is counter-clockwise as viewed from bottom of pump.

3. **Name Plate** - Record the information from the pump name plate to drawing in front of manual for future reference.

4. **Priming** - Every centrifugal pump must be primed (suction pipe and pump's body should have liquid), before operating.

Install the foot valve at the suction pipe *Figure 1* and fill with liquid the superior part of the pump's body. Sometimes air is trapped inside the body, to remove it you should uncap the male plug until the liquids spills out. Re-install the male plug using a sealant.



IMPORTANT! - Do not operate pump without priming first. Operating dry will damage seal.

▶ Starting

When starting for the first time your equipment check that the discharge valve is 90% closed. Gradually open the valve until the motor runs at full load (amperage plate). Never allow the amperage consumed by the pump exceeds the maximum permitted by the engine.

▶ Mechanical seal

Mechanical seals installed in this pumps are lubricated by water, there for the pump should not be operated dry. You will find the appropriate seal for each use and liquid to be pumped, check with your Barmesa Pumps distributor for more information.



IMPORTANT! - Always **unplug the pump before applying maintenance, service or repair to avoid electric shock.**

▶ Maintenance

Body and Impeller - All pump parts are removable by removing nuts and bolts. For body maintenance, disconnect the suction and discharge, and remove the body of the intermediate coupling. For maintenance of the impeller is not necessary to remove the suction or discharge, simply remove the body nuts; this would uncover the impeller. Examine and replace if it shows wear or damage.

When the impeller requires replacement, remove the screw of the shaft, and using a puller, remove the impeller being careful not to abuse the keyway of the shaft.

It is important not to overfill the oil tank because it would cause an increase in pressure by heating, affecting the bearings and seals. In normal operation, the frame temperature increases 122 °F above ambient temperature.

Mechanical Seal - To inspect or replace the shaft seal, remove the body and impeller. If any part shows wear or damage, replace both parts (stationary seat and rotary part). The rotating seal parts may be stuck together with the shaft, this happens when the seal has been assembled for a long time.

If the mechanical seal does not leak and there is need to open the pump for inspection or cleaning, **DO NOT** remove the seal, remove the spring only if the impeller needs to be removed. Once a seal has been in operation is very difficult to remove and reassembly without creating a seal leak.

▶ Disassembly

Mechanical Seal - Perform the steps above. Remove the rotating part. It may be necessary to remove the intermediate link to remove the stationary seat. To do this, remove the nuts and washers that attach the coupling to the motor. When removing the coupling, the steady part will move towards the front seat of the shaft and the sleeve. If the seat does not yield itself, push from the rear of the coupling.



Handle seal parts with extreme care. DO NOT damage lapped surfaces.

▶ Reassembly

Mechanical Seal - Identify all parts of *Figures 7 and 8*. The ring (6) and seat (1) are perfectly polished, so care must be taken not to scratch or smudge. The cleaning during the assembly process is very important.



IMPORTANT! - All parts must be clean before reassembly.

Step 1: Install the intermediate coupling if it was previously removed. Make sure the shaft and cavities, where will it seats, are clean. The shaft sleeve should not be sharp, but a radius of about 1/32". It is recommended that lightly polish the area of the shaft. If the shaft and it radius are perfectly polished, the seal can be relatively easily installed.

Step 2: Install the seat assembly (1 and 2) on the inside of the intermediate coupling, slightly moistening with water on the rubber parts (**do not use grease or oil**). This assembly should be done only manually, meaning without the use of an instrument.

Step 3: Install the rotating portion of the seal without the spring. Moisten the arrow and the inside of the seal with some water (**do not use grease or oil**). With clean, dry hands, insert the rotating portion to the shaft, sliding it abuts the stationary seat. Once the seal is in place, insert the spring (5).

Step 4: Place the impeller and washers; tighten the hex screw.

Figure 7 Mechanical seal - Assembly.

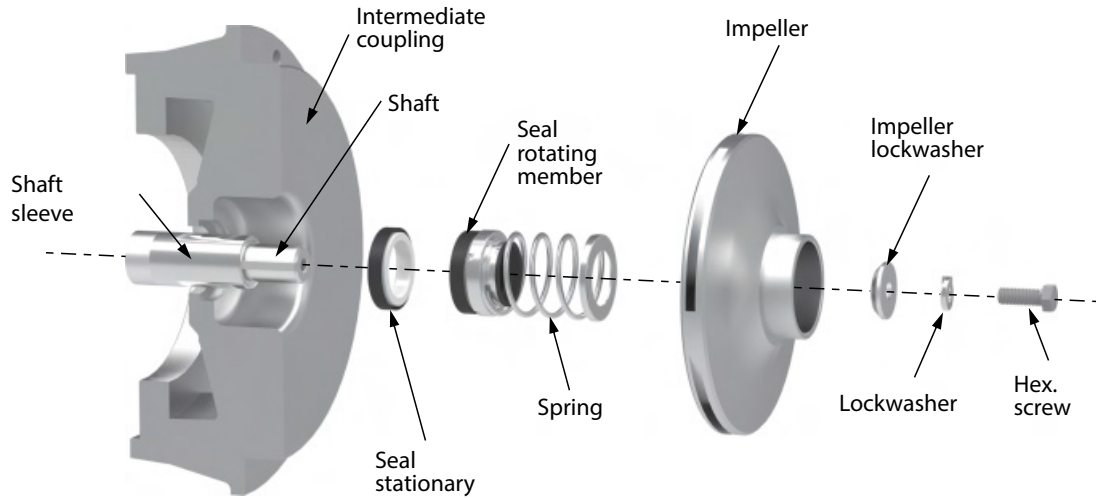

Figure 8 Mechanical Seal - Sectional View.

- 1 - Ceramic seat
- 2 - Seal seat Buna-N
- 3 - Inox. retainer
- 4 - Inox. jacket
- 5 - Inox. spring
- 6 - Carbon ring
- 7 - Elastomer Buna-N
- 8 - Inox. washer

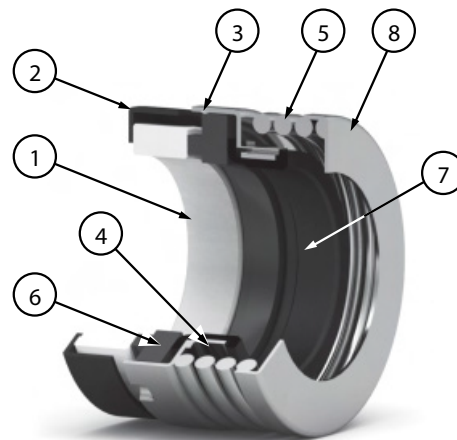













Table 1 Friction in meters x 100 m of piping.

LITERS PER MINUTE	PIPING DIAMETER											GALLONS PER MINUTE
	1"	1¼"	1½"	2"	2½"	3"	4"	5"	6"	8"	10"	
30	4.54											8
37	6.86	1.77										10
45	9.62	2.48										12
57	16.2	4	1.53									15
68	20.6	5.22	2.42									18
76	25.1	6.34	2.94									20
95	38.7	9.6	4.48	1.2	0.54							25
113	54.6	13.6	6.26	1.82	0.75							30
151	95	23.5	10.79	3.1	1.28							40
170	119	29.4	13.45	3.85	1.6							45
189	146	36	16.4	4.67	1.94	0.66						50
208		43.2	19.7	5.51	2.33	0.79						55
227		51	23.2	6.59	2.72	0.92						60
246		59.6	27.1	7.7	3.17	1.07						65
265		68.8	31.3	8.86	3.63	1.22						70
284		78.7	35.8	10.15	4.14	1.39						75
303		89.2	40.5	11.4	4.66	1.57						80
322		100	45.6	12.6	5.27	1.77						85
360		125	56.5	15.8	6.49	2.18	0.57					95
378		138	62.2	17.4	7.11	2.39	0.62					100
416			75.25	21.05	8.55	2.88	0.75					110
454			88.3	24.7	10	3.37	0.88					120
530			119	33.2	13.5	4.51	1.17	0.38				140
568			137.5	38.1	15.45	5.16	1.33	0.43				150
605			156	43	17.4	5.81	1.49	0.48				160
643				48.55	19.65	6.54	1.67	0.54				170
681				54.1	21.9	7.28	1.86	0.6				180
757				66.3	26.7	8.9	2.27	0.73	0.3			200
833				80	32.2	10.07	2.72	0.87	0.35			220
908				95	38.1	12.6	3.21	1.03	0.41			240
984				111	44.5	14.7	3.74	1.2	0.48			260
1060				128	51.3	16.9	4.3	1.38	0.56			280
1135				146	58.5	19.2	4.89	1.58	0.63			300
1324					79.2	26.1	6.55	2.11	0.85			350
1514					103	33.9	8.47	2.72	1.09	0.27		400
1892						52.5	13	4.16	1.66	0.42		500
2082						63.2	15.7	4.94	2	0.5		550
2271						74.8	18.6	5.88	2.34	0.59	0.19	600
2649						101	25	7.93	3.13	0.79	0.25	700
2838							28.7	9.07	3.59	0.91	0.29	750
3028							32.4	10.22	4.04	1.02	0.32	800
3217							36.6	11.56	4.5	1.13	0.36	850
3406							40.8	12.9	5.05	1.27	0.41	900
3595							45.5	14.35	5.61	1.42	0.45	950
3785							50.2	15.8	6.17	1.56	0.5	1000
4163								19.15	7.41	1.87	0.6	1100
4542								22.5	8.76	2.2	0.7	1200
4920								26.45	10.2	2.56	0.81	1300

NOTE: The values in this table refer to frictions and clean water pipes and hoses smooth walls. As used pipe and / or hose rough walls increase the values about 50% to 100%.

Table 1 Equivalent length in meters of straight pipe and valve connections for calculating friction.

PART	DESCRIPTION	DIAMETER									
		1"	1¼"	1½"	2"	2½"	3"	4"	5"	6"	
	STANDARD 90° ELBOW	0.84	1.07	1.22	1.68	1.98	2.44	3.35	4.12	4.88	
	MEDIUM RADIUS ELBOW 90°	0.69	0.92	1.07	1.37	1.68	2.14	2.75	3.51	4.27	
	LONG RADIUS ELBOW 90°	0.54	0.69	0.84	1.07	1.37	1.6	2.14	2.75	3.36	
	STANDARD 45° ELBOW	0.38	0.54	0.61	0.77	0.92	1.15	1.53	1.83	2.29	
	STANDARD TEE	1.68	2.29	2.75	3.36	4.28	5.19	6.71	8.23	10.1	
	ANGLE GLOBE VALVE (OPEN)	3.97	5.49	6.71	8.23	10.7	12.2	16.8	21.3	25.9	
	GLOBE VALVE (OPEN)	7.93	10.7	13	16.8	21.3	24.4	35.1	42.7	48.8	
	GATE VALVE (OPEN)	0.19	0.25	0.29	0.38	0.43	0.54	0.69	0.84	1.07	
	INCREASER	1.21	1.52	1.82	2.74	3.35	4.26	6.09	7.92	10.1	
	REDUCER	0.3	0.3	0.3	0.61	0.61	0.9	1.21	1.21	2.13	
	SUCTION VALVE	0.91	1.21	1.52	2.13	2.74	3.35	4.87	6.4	7.92	



Risk of electric shock. Always disconnect the pump from the power source before handling inspections or repairs.

PROBLEM	PROBABLE CAUSE	CHECK
A) The pump does not prime, the vacuum gauge indicates a lower reading than normal.	1. Air leak in the suction system.	- Threaded joints in the suction tightness. - Gaskets for no wear. - The mechanical seal for leaks. - The drain plug has leaks. - The vacuum gauge may be leaking.
	2. Insufficient liquid in the pump casing.	- That the pump's body is filled with water.
	3. Low operating speed.	- The motor speed (RPM).
	4. Bound pump.	- Impeller rotates freely. - Internal parts are clean.
	5. Mechanical defect.	- That the internal parts are not worn.
B) The pump does not prime, the vacuum gauge reading indicates higher than normal.	1. Pipe clogged suction.	- The suction line is clean.
C) The pump priming good vacuum gauge reading is normal, the manometer indicates a lower pressure than normal.	1. The pump speed is very low.	- The voltage is correct.
	2. Mechanical defects.	- The internal parts for wear.
D) The pump priming good vacuum gauge reading is almost normal, reading the manometer is greater.	1. Discharge obstructed.	- The discharge is clear of obstructions. - That the discharge valves operate correctly.
E) The pump loses its priming during operation, vacuum gauge reading drops to zero.	1. suction dynamic level too high.	- When the pump is operating, never lacks water in the suction.
	2. The pump is sucking air.	- For leaks in suction piping, angles and gaskets. - That there is no vortex effect at the end of the suction, this lack of water.
F) The pump priming pumps well and satisfactorily but noisy.	1. Pump base is loose.	- That screws are tight at the base. - There are no cracks in the base.
	2. Cavitation.	- The dynamic level is not too high - That the pumping capacity is not too much. - The pump is operating in the range of NPSHR - If reducing flow makes the noise gone, then the problem is in the point above; partially close the discharge valve.
	3. Bearings.	- The bearings for wear. - That there is oil in the deposit.
	4. Vibration.	- The impeller does not have any foreign material. - The pump is operating in the range. - That the alignment is correct.
G) Motor overload.	1. Low Voltage.	- The voltage is correct.
	2. Overload.	- The amperage of the plate is not exceeded. - There is no foreign material that may force the impeller. - That the motor is suitable for the pump.

NOTE: Flo Fab Pumps assumes no responsibility for damage or injury due to disassembly in the field. Disassembly of the pumps or supplied accessories other than at Flo Fab Pumps or its authorized service centers, automatically voids warranty.

