



# Circulating Pumps

## Series 500



available in both the single and twin version.

[www.flofab.com](http://www.flofab.com)

001-cat-2016-500

# TABLE OF CONTENTS



<b>SERIES 500 PUMPS CURVES COMPARISON.....</b>	<b>2</b>
<b>500-1x1-GPA-5F-VFD - TECHNICAL DATA.....</b>	<b>3</b>
<b>500-1x1-GPA-5F-VFD - PERFORMANCE CURVES.....</b>	<b>4</b>
<b>500-1x1-GPA-5F-VFD - MATERIALS.....</b>	<b>5</b>
<b>500-1X1-GPA-10F-VFD - SETTINGS.....</b>	<b>6</b>
<b>500-1X1-GPA-10F-VFD - PERORMANCE CURVES.....</b>	<b>7</b>
<b>500-1X1-GPA-10F-VFD - DIMENSIONS &amp; WEIGHT / PRODUCT SPECIFICATIONS.....</b>	<b>8</b>
 <b>SERIES 500 : (500-2x2-FF-100-280.50-VFD - 500-2x2-FF-180/280.50-VFD - 500-2.5x2.5-FF-150-340.65-VFD) available in both the single and twin version.</b>	
<b>CONSTRUCTION FEATURES.....</b>	<b>9</b>
<b>PRODUCT SPECIFICATIONS.....</b>	<b>9-10</b>
<b>MATERIALS.....</b>	<b>11</b>
<b>OPERATING MODES.....</b>	<b>12-13</b>
<b>CONFIGURATIONS.....</b>	<b>14-15</b>
<b>DESCRIPTION OF SYMBOLS.....</b>	<b>16-17</b>
<b>TROUBLESHOOTING.....</b>	<b>18</b>
<b>CONNECTION DIAGRAM.....</b>	<b>19</b>
<b>DIGITAL INPUTS.....</b>	<b>20</b>
<b>500-2x2-FF-100/280.50-VFD.....</b>	<b>21</b>
<b>500-2x2-FF-180/280.50-VFD.....</b>	<b>22</b>
<b>500-2.5x2.5-FF-150/340.65-VFD.....</b>	<b>23</b>

## HISTORY

Flo Fab was established in 1981 by Denis Gauvreau who created and developed the products line and constantly being perfected by Marc Gauvreau, as well as by a team of professional engineers and designers. It's a combination of existing designs from several renowned products and the innovative ideas of a new generation professionals.

Through the years, Flo Fab has acquired several companies and service entities including : AQUA-PROFAB (ASME Tanks manufacturer), MÉNARD, LÉONARD ÉLECTRIQUE, PMA. , Furthermore Flo Fab purchased equipment, fabrication designs and patterns from IDEALCO, a manufacturer of shell and tube type heat exchangers.

The after sales services, sales, engineering, R&D, production, quality control, accounting and administration departments of all the above companies share the same location.

In December 2014, Marc Gauvreau, son of the founder, acquired all shares of The company. Flo Fab and is constantly investing in new state of the art innovations new product like the XRI series and Prefab Skid for Hydronic Heating & cooling system, pumping systems. This has allowed Flo Fab to retain competent and experienced staff of professionals with varied and specialized abilities that constantly work on improving our existing products and add new engineered solutions that exceeding customer's expectations .

Flo Fab has grown quite rapidly and now proudly offers of a wide range of products available directly from one manufacturer. This includes pumps & pump packages, tanks, heat exchangers & hydronic accessories. This allows each project stakeholders to enjoy economical savings, peace of mind, best value for their investment and optimized total cost of ownership.



# Comparison Curves Between All Pumps Shown

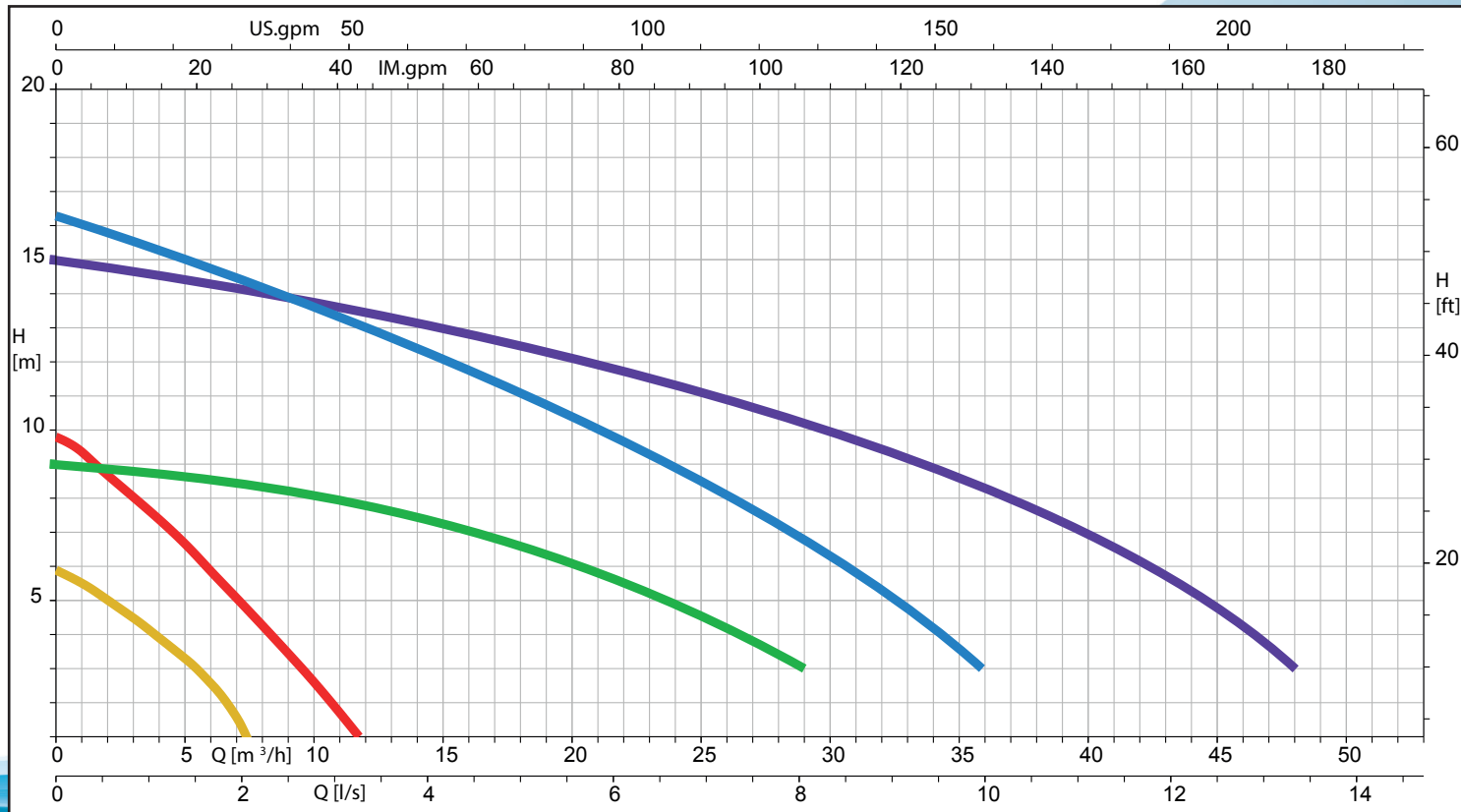

- 500-1x1-GPA-5F-VFD**
- 500-1X1-GPA-10F-VFD**
- 500-2x2-FF-100/280.50-VFD**
- 500-2x2-FF-180/280.50-VFD**
- 500-2.5x2.5-FF-150/340.65-VFD**





**Operating range:** 0.8 - 13.2 gpm with head up to 18 ft.

**Pumped liquid temperature range:** from +36 °F (2°C)  
to +203 °F (95°C).

**Working pressure:** 145 psi 10 bar (1000 kPa).

**Protection class:** IP 44.

**Insulation class:** F

**Installation:** with horizontal motor axis.

**Standard power input:** single-phase 1 x 110-127 V~ 60 Hz.

**Pumped liquid:** Clean, free of solids and mineral oils, non-viscous, chemically neutral, with properties similar to water (glycol max 30%).





# • Specifications

The performance curves are based on kinematic viscosity values = 1 mm<sup>2</sup>/s and density equal to 1000 kg/m<sup>3</sup>; Curve tolerance according to ISO 9906.

MODEL	Q=gpm	0	2	4	6	8	10	12
500-1x1-GPA-5F-VFD	H (ft)	18.4 ft	15.5 ft.	12.8 ft.	10.3 ft.	8.2 ft.	6.2 ft.	4.3 ft.

CENTER DISTANCE "/mm	FLANGE	POWER INPUT 60 Hz	P1 MAX W	In A	EEI *	MINIMUM SUCTION PRESSURE	
						t°	194 °F/90°C
6 3/8" / 162mm	OVAL 2 BOLT	1 x 110-127 V~	12 34	0.19 0.50	EEI ≤ 0,23	ft.	32.8

L	L1	L2	B	B1	B2	H	H1	H2	A	F	F1	PACKING DIMENSIONS			VOLUME ft <sup>3</sup>	WEIGHT lbs/kg
												L	B	H		
6 3/8"	3 2/3"	2 1/3"	4"	3"	1 1/32"	4 3/4"	2 7/8"	2"	1 1/2"	3 7/64" 3 15/64"	4 9/64"	5 1/8"	7 1/2"	5 29/32"	0.095	5.29/2.4

# • Performance Curve

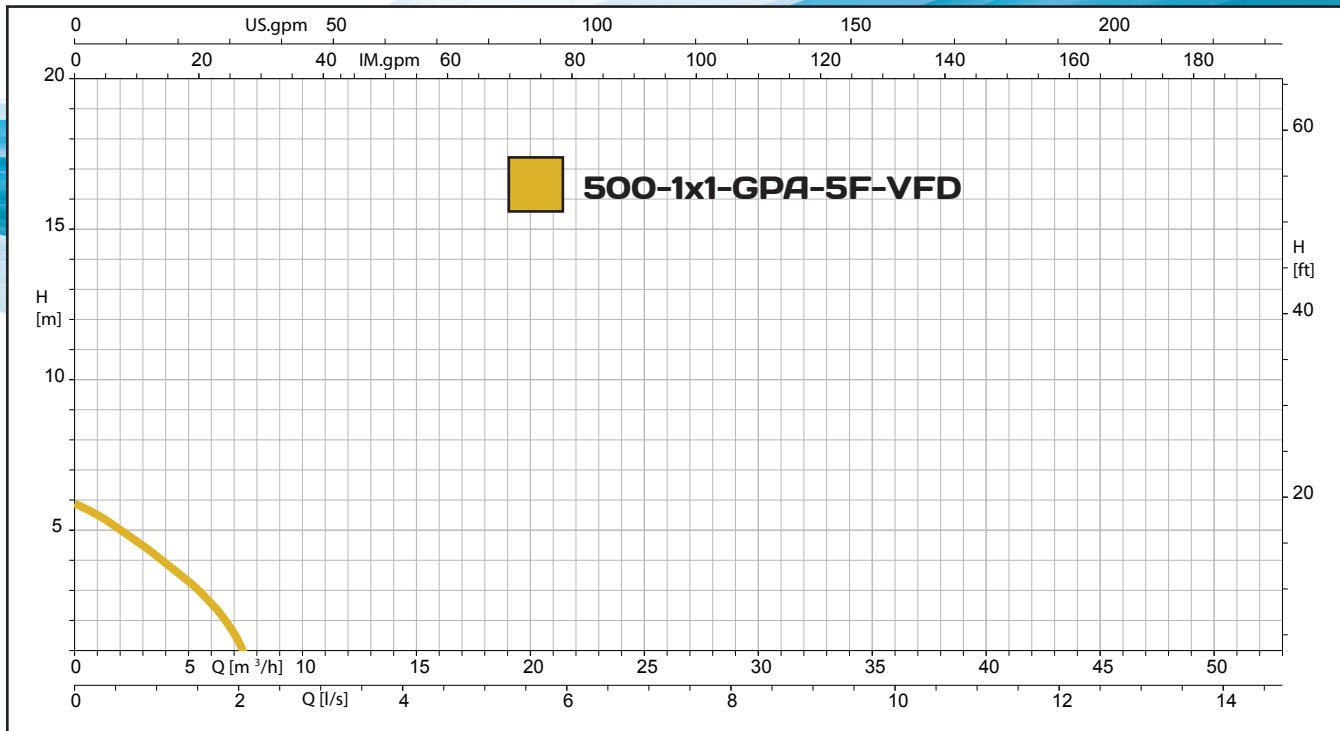

# Materials

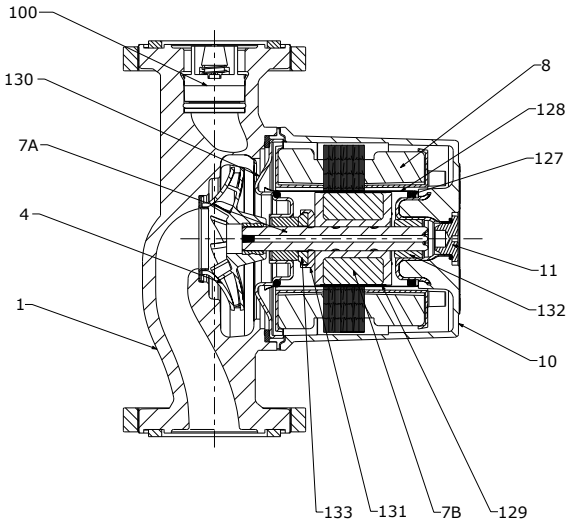

N.	PARTS	MATERIALS
1	PUMP BODY	CAST IRON
4	IMPELLER	TECHNOPOLYMER ULTEM
7A	MOTOR SHAFT	CERAMIC
7B	ROTOR	MAGNET
8	STATOR	-
10	MOTOR CASING	DIE-CAST ALUMINUM
11	BREATHER PLUG	BRASS
100	CHECK VALVE	TECHNOPOLYMER PPE
127	SEAL RING	EPDM
128	STATOR LINER	STAINLESS STEEL
129	ROTOR LINER	STAINLESS STEEL
130	CLOSING FLANGE	STAINLESS STEEL
131	THRUST RING SUPPORT	EPDM
132	BUSHINGS	GRAPHITE
133	THRUST RING	CERAMIC

## OPERATING MODES

### CONSTANT SPEED OPERATION

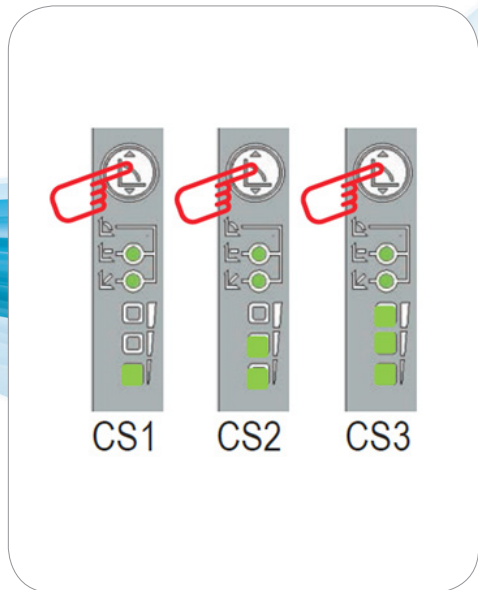

### CONSTANT PRESSURE OPERATION

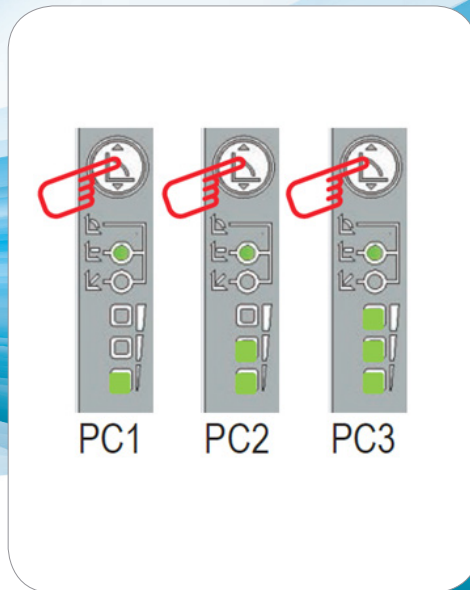

### PROPORTIONAL PRESSURE OPERATION

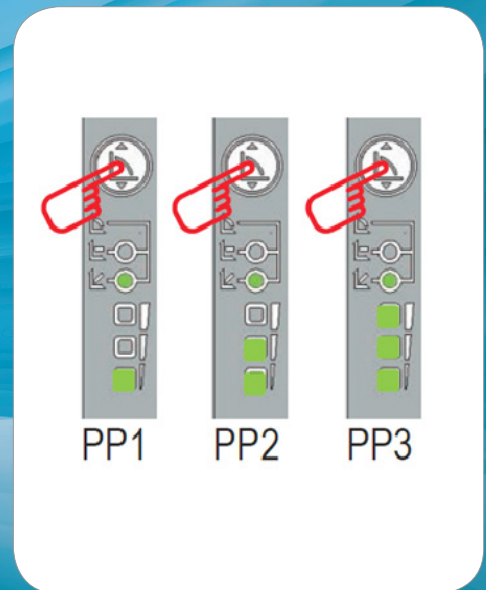

### 2 Bolt Flange

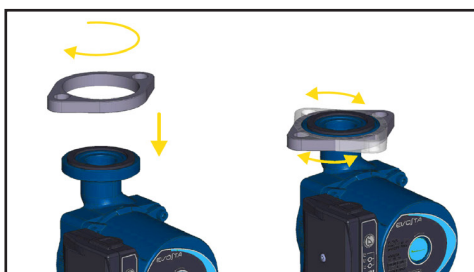

### Check Valve



### 360° Rotation around a vertical access

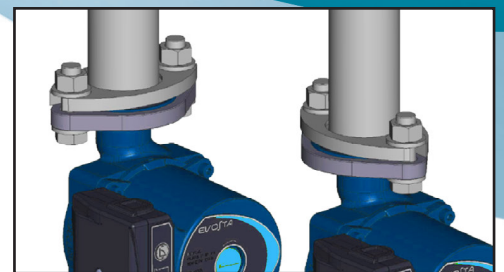





Setting	Performance curve	Function
AUTO (factory setting)	Running within Defined Range	The "Auto-adapting" function automatically controls the pump performance within the specified performance range. (1) Adjusting pump performance according to the system sizing. (2) Adjusting pump performance according to the variation of load history. When it comes to "Auto-adapting", the pump control mode of the pump is proportional pressure control.
BL	Proportional Pressure Curve	The operation performance point of the pump moves forward or backward along the proportional pressure curve, depending on the flow demand. The pressure of pump decreases at falling flow demand and increases at rising flow demand.
HD	Constant Pressure Curve	Based on the flow demand of the system, the operating performance point of the pump moves in or out the constant curve. The pressure of the pump stays remain, irrespective of the flow.
HS	Constant Speed Curve	The pump runs at certain speed and performs a constant curve. For speed/rate mode, it means the pump performs the curve under all operating conditions. To set the pump to mode for only a short period of time means rapid pump venting.



# ● Performance Curves

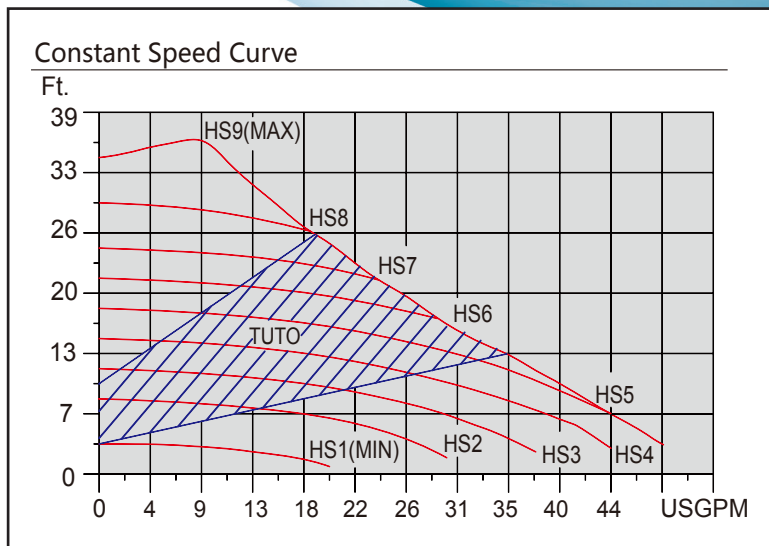
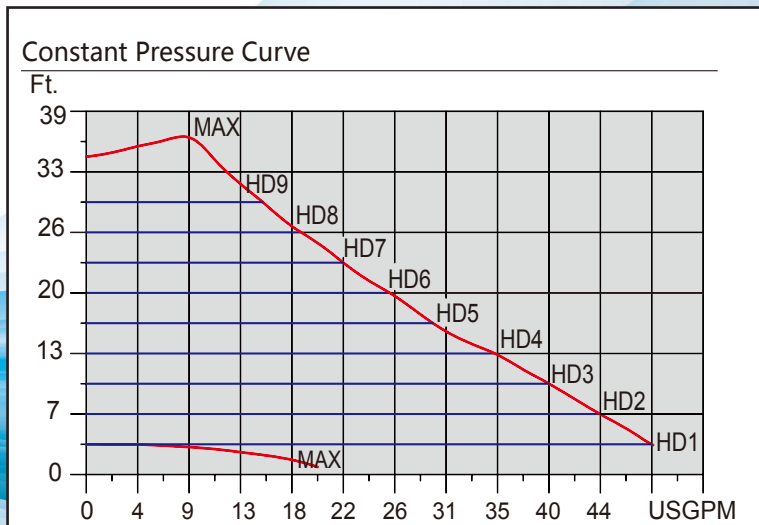
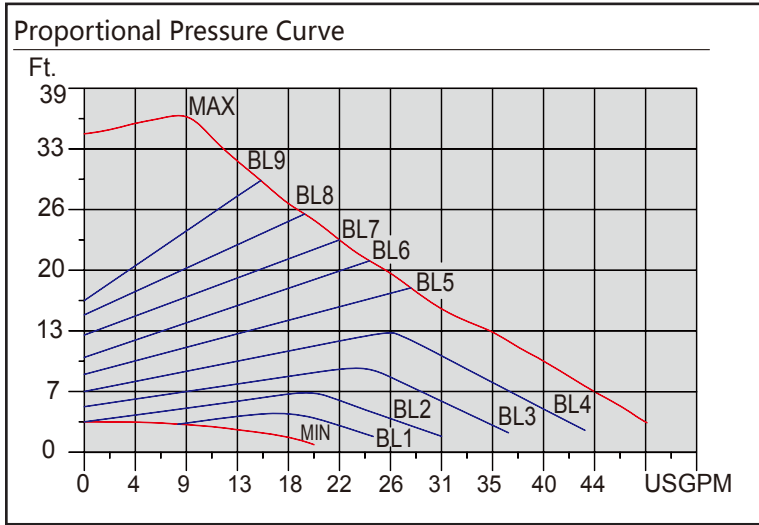





# ● Dimensions and Weight

Model	Material of pump body		Dimension(mm)/(inches)						
	Cast iron	Stainless Steel	L1	L2	B1	B2	H1	H2	G
500-1X1-GPA-10F-VFD	●	●	90/3	180/7	80/3	160/6	144/6	199/8	1 1/2"

## Product Specifications

Model	Max. Flow (m <sup>3</sup> /h)	Max. Head (m)	Power(W)		Current(A)		Voltage/Frequency (V/Hz)	Weight.(kg)/(lb)	
			Min.	Max.	Min.	Max.		G.W.	N.W.
500-1X1-GPA-10F-VFD	7	10	10	185	0.1	1.25	110/1" 230/1" 50/60Hz	4.5/10	5/11



## SERIES 500 PUMPS

### Series 500

100/280.50-VFD  
180/280.50-VFD  
150/340.65-VFD



**All models are available in both the single and twin version.**

#### CONSTRUCTION FEATURES

for small community systems (Electronic device) \* FLO FAB circulators are controlled by means of an IGBT-based device in NPT-technology of the latest generation for higher efficiency and robustness.

Specific features includes:

- Sine wave modulated PWM
  - High carrier frequency to eliminate all audio band noise
  - 2 dedicated 32-bit processors:
    - one dedicated to motor control
    - one dedicated to the user interface allowing the following functions:
      - start/stop control
      - Economy control
      - 0-10V analogue signal control
      - PWM signal control
      - 4-20 mA analogue signal control
      - $\Delta T$  Temperature sensor signal control
      - Connection to ModBus control systems.
- Optional Lonbus with relative module.
- Optimised space vector algorithm
  - Alarm system availability
  - Indication pump running

#### \* Available input when the associated operation is activated

An intuitive and functional user interface ensures ease of calibration for all users. The easy to read OLED display on the control panel, three easy navigation keys, a drop down menu in line with the latest trends in the field of mobile telephony and a very wide range of functions mean that FLO FAB circulators are truly revolutionary products. A reliable and robust construction combined with a modern and innovative design completes the product also from an aesthetic point of view.

## Product Specifications

**Operating range:** 3 to 75,6 m<sup>3</sup>/h with head up to 18 meters;

**Liquid temperature range:** from -10 °C a +110 °C

**Pumped liquid:** clean, free of solid contaminants and mineral oils, non-viscous, chemically neutral, close to the properties of water. (max. glycol contents 30%).

**Maximum working pressure:** 16 bar (1600 kPa)

**Standard flanging:** DN 32, DN 40, DN 50, DN 65, PN 6 / PN 10 / PN 16 (4 slots), DN 80 and DN 100, PN 6 (4 slots)

**Maximum ambient temperature:** +40°C.

**Minimum suction pressure:** the values are given in the relevant tables.

**Special executions on request:** DN 80 , DN 100 PN 10 / PN 16 (8 holes)

**Accessories (Counterflanges):** PN 10 DN 32 - DN 40 - DN 50 - DN 65  
PN 6 DN 80 - DN 100

**Electromagnetic compatibility:** FLO FAB circulators comply with standard EN 61800-3, in category C2, in terms of electromagnetic compatibility.

Electromagnetic emissions - Residential environment (containment measures may be necessary in certain cases). Conducted emissions - Residential environment (containment measures may be necessary in certain cases).





# ● Product Specifications

### **Applications**

FLO FAB electronic circulators can be used in heating, ventilation and air conditioning systems for residential and commercial buildings including:

- Large residential buildings • Condominiums and apartment blocks • Homes
- Clinics and Hospitals • Schools • Office buildings • Real Estate Assets

**All models are available in both the single and twin version.**

Made with bronze pump body for secondary hot water circulation. Available in single version with 1 1/2" threaded connection as well as DN 32 and DN 40 flanged connection.

Compatible for external signal 0-10 or PWM and for communication between devices Modbus (Lonbus with dedicated communication module).

### **Applications in Heating**

The heating required in various applications changes significantly during the day/night due to the ambient temperature and changing occupancy levels. This situation is compounded by the different requirements of the various rooms and opening or closing of the various circuit branches in complex installations. Electronically controlled wet rotor pumps constantly ensure, in almost all correctly sized installations, sufficient power and, simultaneously, lower noise emissions, greater comfort and a significant reduction in running costs.

### **Applications in Air Conditioning**

Unlike conventional electronic pumps, FLO FAB electronic circulators can also be used in air conditioning systems where the temperature of the liquid pumped is lower than the ambient temperature. In these conditions condensate tends to form on the outer surface of the circulator although this does not impair proper operation of either the electronic or mechanical sections. The unit is designed and sized in such a way as to allow the condensate to drain without damaging the construction components.

### **Application for Hot Water Circulation**

The Bronze version pump with bronze body has been developed specifically for the circulation of secondary hot water. The constant temperature operating mode controls the water temperature in the circulation pipe without needing to use thermostatic valves, thus maintaining required water temperature for user.

### **Construction Features**

Enbloc circulator composed of cast iron hydraulic section and wet rotor synchronous motor. Motor casing in aluminum. Scroll type pump body featuring high hydraulic efficiency thanks to highly precise design and smooth internal surfaces. Flanged suction and discharge ports equipped with threaded fittings for pressure and temperature readings. The single version is supplied as standard with insulating covers to avoid heat loss and/or the formation of condensate on the pump body. Insulation of the twin version is to be provided by the installer. Use special caution to avoid obstructing the condensate drainage labyrinths in order to avoid impairing operation. Impeller in technopolymer, motor shaft in hardened stainless steel held in ceramic bearings lubricated by the pumping medium. Rotor protective jacket in stainless steel. Ceramic thrust ring, ethylene propylene seals and stator jacket in carbon fiber composite. Permanent magnet synchronous motor. The twin version features an automatic swing check valve incorporated in the discharge port to avoid water recirculating through the unit when it is not running; moreover, a blank flange is supplied as standard to allow either of the two motors to be removed for servicing. Standard execution of the pump body is PN 16. Both the DN 80 and the DN 100 PN 16 (8 holes) versions can be supplied on request

Circulator protection rate: IP X4D

Insulation Class: F

Standard voltage: single-phase 220/240 V , 50/60Hz

Sound pressure level ≤45 dB(A)

This product complies with European standards EN 61800-3 – EN 60335-1 – EN 60335-2-5151

# • Materials

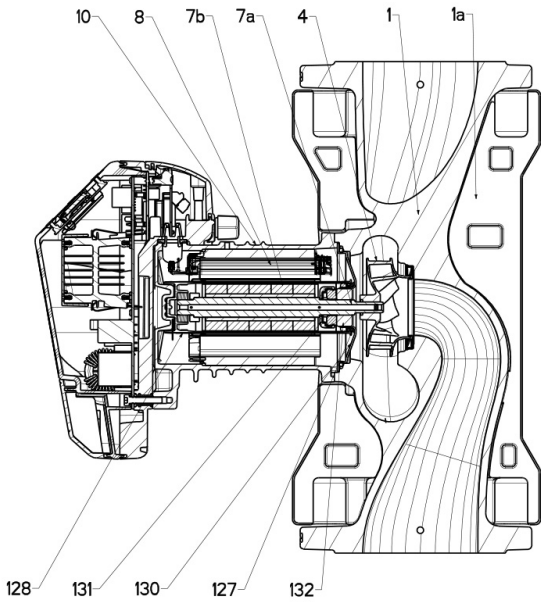

N.	PARTS	MATERIALS
1	PUMP BODY	CAST IRON 250 UNI ISO 185 - CTF BRONZE (BRONZE VERSION)
4	IMPELLER	TECHNOPOLYMER
7A	MOTOR SHAFT	STAINLESS STEEL
7B	ROTOR	STAINLESS JACKET
8	STATOR	-
10	MOTOR CASING	DIE-CAST ALUMINUM
127	SEAL RING	RUBBER EPDM
128	STATOR SLEEVE	COMPOSITE WITH CARBON FIBRE
130	CLOSING FLANGE	STAINLESS STEEL
131	THRUST RING SUPPORT	STAINLESS STEEL
132	BUSHINGS	ALUMINA





## ● Operating Modes

All functions listed below can be consulted by all users (irrespective of the level of expertise) simply by scrolling through the menu. Calibration and parameter editing are protected and reserved for expert users. The FLO FAB range is factory-set to the control mode with differential pressure proportional to the curve that guarantees the best energy efficiency index (EEI).

### 1 - $\Delta P$ -v proportional differential pressure control mode

Control mode  $\Delta P$ -v provides linear variation of the head delivery value from Hsetp to Hsetp/2 in accordance with changes in flow rate. This control mode is particularly useful in the following types of installations:

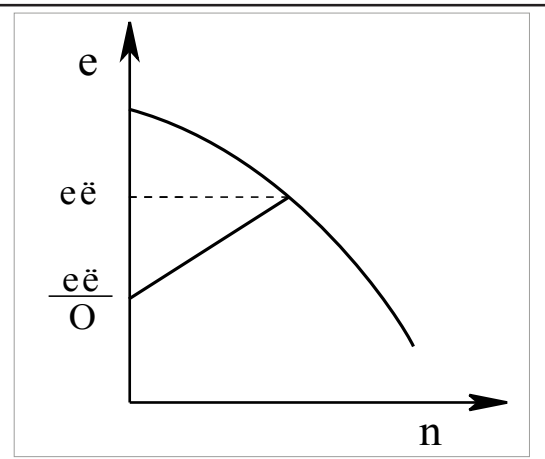

#### a. two-pipe central heating systems with thermostatic valves and with:

- head of more than 4 metres;
- very long circuit piping;
- valves with broad operating range;
- differential pressure regulators;
- high pressure drops in sections of the system carrying the entirety of the water flow rate;
- low differential temperature.

#### b. Under-floor central heating systems and systems with thermostatic valves and significant pressure drops in the boiler circuit.

#### c. Installations having primary circuit pumps with high pressure drops.

### Examples of set-point input with $\Delta P$ -v

The following operating point is required:

$Q = 6,5 \text{ m}^3/\text{h}$

$H = 6 \text{ m}$

#### PROCEDURE:

1. In the graph, find the required operating point and then find the nearest curve to it (in this case the point lies precisely on the curve)
2. Follow the curve until intersecting the circulator limit curve.
3. The head reading found at this limit point will be the set-point head to be entered to obtain the required operating point.

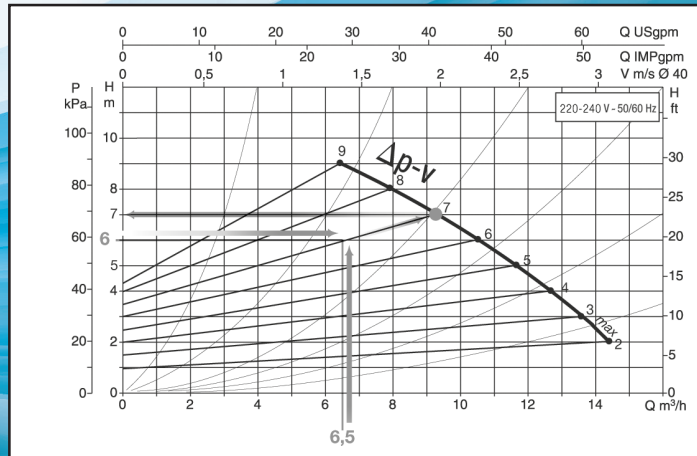

### 2 - $\Delta P$ -c constant differential pressure control mode

Control mode  $\Delta P$ -c keeps system differential pressure constant at the user-settable value of H setp despite changes in flow rate.

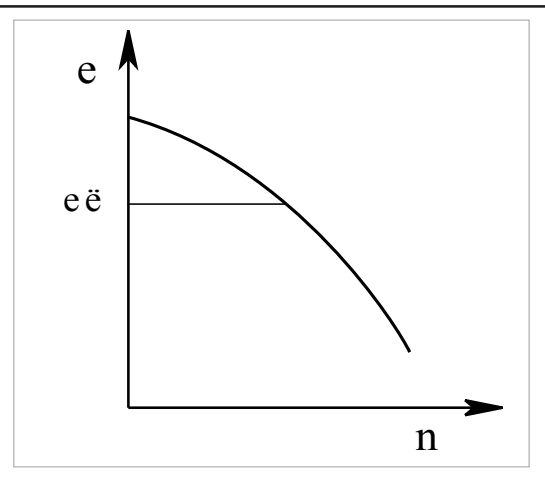

This control mode is particularly useful in the following types of installations:

#### a. two-pipe central heating systems with thermostatic valves and with:

- head of less than 2 metres;
- natural circulation;
- low pressure drops in sections of the system carrying the entirety of the water flow rate;
- high differential temperature (central heating).

#### b. Under-floor central heating systems with thermostatic valves

#### c. Single-pipe central heating systems with thermostatic valves and calibration valves

#### d. Installations having primary circuit pumps with low pressure drops.

## ● Operating Modes

### 3 - Constant curve control mode

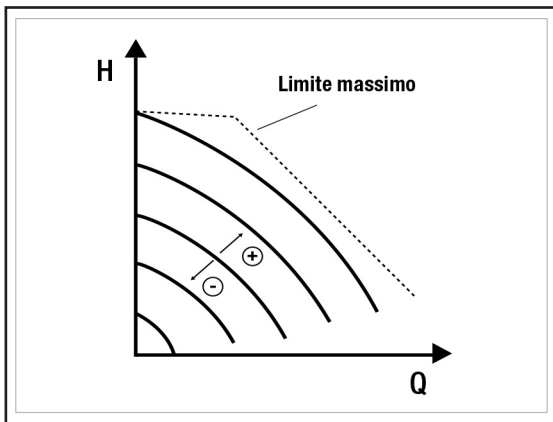

This control setting shows the curve of the circulator at constant speed. The operation curve is selected by setting the rotation speed on a percentage factor. Reaching 100% indicates the curve maximum. The speed of rotation may depend on power restriction and difference in pressure subject to model of circulator. The rotation speed can be set from the display or from an external signal 0-10V or PWM using the multifunction module.

The control setting is ideal for heating and air conditioning applications that require constant flow.

### 4 - Constant and proportional differential pressure control mode depending on water temperature.

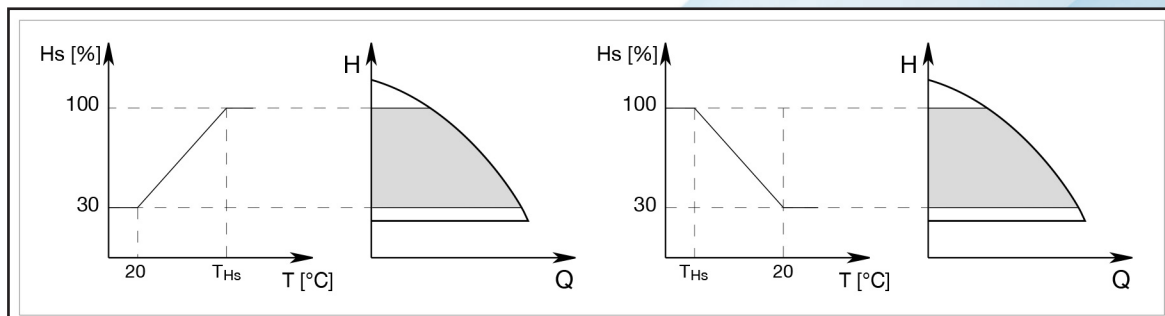

**The circulator head set-point is reduced in accordance with the water temperature. Liquid temperature can be set from 0°C to 100°C.**

This control mode is particularly useful in the following types of installations:

- in variable flow rate installations (two-pipe central heating systems), in which a further reduction of circulator performance is provided in accordance with lowering of the circulating liquid temperature, in the presence of reduced heating demand.
- in constant flow rate installations (single-pipe and under-floor central heating systems), where the performance of the circulator can be adjusted only by activating the temperature influence function.

This function is set on SERIES 500 control panel.

### 5 - $\Delta T$ -c constant differential temperature control mode \*

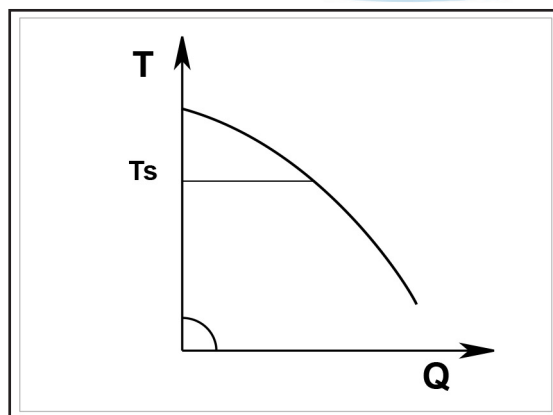

$\Delta T$ -c control mode keeps the differential temperature of the pumped liquid constant, changing the flow rate to the user-settable value  $T_{setp}$ .

This control mode is particularly useful in the following types of installations:

- Under-floor central heating systems
- Installations having circuit pumps with heat exchanger
- Solar energy systems with storage tanks
- Swimming pool heating systems with solar panels

\* Operation mode in development progress

## Economy Function

The economy function can be set directly on the control panel, by setting a reduction value (f.rid) the maximum value of which is 50%. In all settings listed above the Hset value must be replaced with a Hset x f.rid value.

## ● Menu Configurations

The settings are made when passing from one page to another, in the circulator configuration menu.

### Home Page

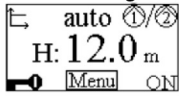

The main settings of the system are graphically summed up on the Home Page.  
 The icon at top left indicates the type of regulation selected.  
 The icon at centre top indicates the operating mode selected (auto or economy).  
 The icon at top right indicates the presence of a single ① or twin inverter ②/①.  
 The rotation of the icon ① or ② indicates which circulation pump is operating.

At the centre of the **Home Page** is a read-only parameter which can be chosen from a small set of parameters on Page 9.0 of the menu.

From the Home Page it is possible to access the page for **regulating the contrast** of the display: hold down the hidden button, then press and release the right button.

### Page 1.0

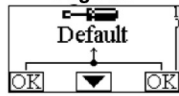

FLO FAB circulators offer 2 menus: **user menu** and **advanced menu**. The user menu is accessible from the Home Page by pressing and releasing the central “Menu” button.









The user menu is accessible from the Home Page by holding down the central “Menu” button for 5 seconds.

The factory settings are set from **Page 1.0** by holding down the left and right buttons at the same time for 3 seconds. The resetting of the factory settings will be notified by the appearance of the symbol  next to the word “Default”.

### Page 2.0



The regulating mode is set from **Page 2.0**. You can choose between the following modes:

1.  = Proportional differential pressure regulation.
2.  = Proportional differential pressure regulation with set-point set by external signal (0-10V or PWM).
3.  = Proportional differential pressure regulation with set-point depending on temperature.
4.  = Regulation with constant differential pressure.
5.  = Constant differential pressure regulation with set-point set by external signal (0-10V or PWM).
6.  = Constant differential pressure regulation with set-point depending on temperature.
7.  = Regulation with constant curve with rotation speed set from the display.
8.  = Regulation with constant curve with rotation speed set by an external signal (0-10V or PWM).

Page 2.0 displays 3 icons which represent:  
 central icon = setting currently selected  
 right icon = next setting  
 left icon = previous setting

### Page 3.0

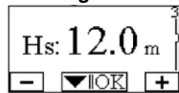

The regulating set-point can be modified from **Page 3.0**.

Depending on the type of regulation chosen on the previous page, the set-point to be set will be a head or, in the case of a Constant Curve, a percentage of the rotation speed.

### Page 4.0



On **Page 4.0** it is possible to modify the parameter THs with which to make the curve depending on temperature (see Par. 10.1.4).

This page will be displayed only for the regulating modes depending on fluid temperature.

### Page 5.0

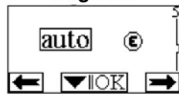

**Page 5.0** allows you to set the “auto” or “economy” operating mode.

“Auto” mode disables the reading of the status of digital input IN2 and in fact the system always activates the set-point set by the user.

“Economy” mode enables the reading of the status of digital input IN2. When input IN2 is energised the system activates a percentage reduction of the setpoint set by the user (Page 6.0 of the FLO FAB menu).

### Page 6.0

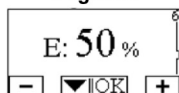

For the connection of the inputs see par. 8.2.1

**Page 6.0** is displayed if “economy” mode has been chosen on page 5.0 and allows setting of the percentage value of the set-point. This reduction will be carried out if digital input IN2 is energised.

### Page 7.0



**Page 7.0** is displayed if an operating mode has been chosen with set-point regulated by an external signal.

This page allows you to choose the type of control signal: analogue 0-10V (positive or negative increase) or PWM (positive or negative increase).



## Menu Configurations

### Page 8.0

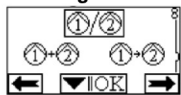

If a twin system is used (see Par. 8.3) on **page 8.0** you can set one of the 3 possible twin operation modes:

- Alternate every 24h:** The 2 circulators alternate in regulation every 24 operating hours. If one of the 2 malfunctions, the other takes over regulation.
- Simultaneous:** The 2 circulators work at the same time and at the same speed. This mode is useful when a flow rate is required that cannot be provided by a single pump.
- Main/Reserve:** Regulation is always performed by the same circulator (Main), the other (Reserve) takes over only if there is a malfunction of the Main one.

If the twin communication cable is disconnected the systems automatically figure as Single, working completely independent of each other.

### Page 9.0



On **page 9.0** it is possible to choose the parameter to be displayed on the Home Page:

- H** : Measured head expressed in metres
- Q** : Estimated flow rate expressed in m<sup>3</sup>/h
- S** : Rotation speed expressed in revs per minute (rpm)
- E** : Head requested by external signal 0-10V or PWM, if active
- P** : Power distributed expressed in kW
- h** : Operating hours
- T** : Liquid temperature measured with the sensor fitted on board
- T1** : Liquid temperature measured with an external sensor

### Page 10.0



On **page 10.0** you can choose the language in which to display the messages.

### Page 11.0



On **page 11.0** you can display the alarms log by pressing the right button.

If the system finds any faults it records them permanently in the alarms log (up to a maximum of 15 alarms). For each recorded alarm a page composed of 3 parts is displayed: an alphanumeric code that identifies the type of fault, a symbol that illustrates the fault in graphic mode, and a message in the language selected on Page 10.0, giving a brief description of the fault.

By pressing the right button you can scroll through all the pages of the log.  
2 questions appear at the end of the log:

### Storico Allarmi

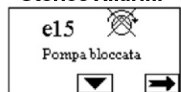

#### 1. "Reset Alarms?"

Pressing OK (left button) resets any alarms still present in the system.

#### 2. "Delete Alarms Log?"

Pressing OK (left button) deletes the alarms memorised in the log.

### Page 12.0



On **page 12.0** you can set the system status in ON, OFF or controlled by a remote signal EXT (digital input IN1).

If ON is selected the pump is always on.

If OFF is selected the pump is always off.

If EXT is selected, reading of the status of digital input IN1 is enabled. When input IN1 is energised the system goes ON and the pump is started (on the Home Page the messages "EXT" and "ON" appear alternately at bottom right); when input IN1 is not energised the system goes OFF and the pump goes off (on the Home Page the messages "EXT" and "OFF" appear alternately at bottom right).

For the connection of the inputs see par. 8.2.1

## Description of Symbols Displayable Quantities

Symbol	Description
H Q S E T P h T1	Shows parameters
H	Head in metres
Q	Flow rate in m <sup>3</sup> /h Q < Q <sub>min</sub> when Q is less than 30% of Q <sub>max</sub> Q = 0 only when the pump is switched off.
S	Speed in revs/minute (rpm)
E	Analog input 0-10V or PWM
T	Liquid temperature in °C – input D
P	Power in kW
h	Working hours
T1	Liquid temperature in °C – input C (available with additional temperature sensor)
T <sub>Hs</sub>	Maximum liquid temperature in °C depending on regulation

### CIRCULATOR STATUS

Symbol	Description
①	Single circulator or nr. 1
②	Circulator nr. 2
②/①	Alternate twin circulators
②+①	Principal/reserve twin circulators (24 hours one motor / 24 hours the other motor)
②+①	Simultaneous twin circulators
ON	Circulator on
OFF	Circulator off
EXT	Circulator controlled by remote signal (ref. terminals 1-2)



### TYPE OF OPERATION

Symbol	Description
auto	Auto function
Ⓔ	Economy function



### TYPES OF CONTROL MODE

Symbol	Description
↔	Δp-c control mode (constant pressure)
↔ Ⓣ	Δp-c control mode depending on temperature
↘	Δp-v control mode (variable pressure)
↘ Ⓣ	Δp-v control mode depending on temperature
↷	Servomotor control mode with speed set on the display
↷ 10V	Servomotor control mode with speed set by remote signal 0-10V
ΔT-c	ΔT-c control mode (constant temperature)















## Description of Symbols Displayable Quantities

Symbol	Description
	Control panel blocked
 	Multifunction key for confirming parameters and scrolling pages

### FACTORY SETTINGS











Parameter	Value
Control mode	Display of parameters
Hs (Differential Pressure Set-point)	 $\Delta p-v$
Fs (Frequency Set-point)	auto
Set-point percentage reduction	50 %
Twin operating mode	 = Alternating every 24h
Pump start control	EXT (from remote signal on input I1)

### TYPES OF ALARMS AND HOW TO DEAL WITH THEM

Alarm code	Alarm symbol	Alarm description
e0 - e16; e21		Internal Error
e17 - e19		Short Circuit
e20		Voltage Error
e22 - e31		Internal Error
e32 - e35		Electronic system excess temperature
e37		Low voltage
e38		High voltage
e39 - e40		Pump blocked
e43 - e44 - e45 - e54		Pressure Sensor
e46		Pump Disconnected
e42		Dry operation
e56		Motor excess temperature (motor protector trips)
e57		Frequency of PWM external signal less than 100 Hz
e58		Frequency of PWM external signal greater than 5 kHz



## ● Troubleshooting

Error condition			
Display indication		Description	Reset sequence
e0 - E16		Internal error	<ul style="list-style-type: none"> <li>- Switch off system power.</li> <li>- Wait for the warning lights on the control panel to go off, then power the system again.</li> <li>- If the error persists, change the circulator.</li> </ul>
e37		Low mains voltage (LP)	<ul style="list-style-type: none"> <li>- Switch off system power.</li> <li>- Wait for the warning lights on the control panel to go off, then power the system again.</li> <li>- Check that the mains voltage is correct, if necessary reset it at the plate values.</li> </ul>
e38		High mains voltage (HP)	<ul style="list-style-type: none"> <li>- Switch off system power.</li> <li>- Wait for the warning lights on the control panel to go off, then power the system again.</li> <li>- Check that the mains voltage is correct, if necessary reset it at the plate values.</li> </ul>
e32-e35		Critical overheating of electronic parts	<ul style="list-style-type: none"> <li>- Switch off system power.</li> <li>- Wait for the warning lights on the control panel to go off.</li> <li>- Check that the system ventilation ducts are not blocked and that the environment temperature of the premises is correct.</li> </ul>
e43-e45-e54		Sensor signal absent	<ul style="list-style-type: none"> <li>- Check sensor connection</li> <li>- If the sensor is faulty, replace it</li> </ul>
e39-e40		Protection against overcurrent	<ul style="list-style-type: none"> <li>- Check that the circulator turns freely</li> <li>- Check that any antifreeze added does not exceed the maximum percentage of 30%.</li> </ul>
e21-e30		Voltage Error	<ul style="list-style-type: none"> <li>- Switch off system power.</li> <li>- Wait for the warning lights on the control panel to go off, then power the system again.</li> <li>- Check that the mains voltage is correct, if necessary reset it at the plate values.</li> </ul>
e31		Twin communication absent	<ul style="list-style-type: none"> <li>- Check that the twin communication cable is intact.</li> <li>- Check that both circulators are powered.</li> </ul>
e42		Dry operation	<ul style="list-style-type: none"> <li>- Put the system under pressure.</li> </ul>
e56		Motor excess temperature	<ul style="list-style-type: none"> <li>- Switch off system power.</li> <li>- Wait for the motor to cool down</li> <li>- Power the system again</li> </ul>
e57-e58		$f < 100 \text{ Hz} ; f > 5 \text{ kHz}$	<ul style="list-style-type: none"> <li>- Check that the PWM external signal is operating and connected as specified.</li> </ul>

### INSTALLATION:

#### HEATING AND CONDITIONING

#### ONLY HEATING

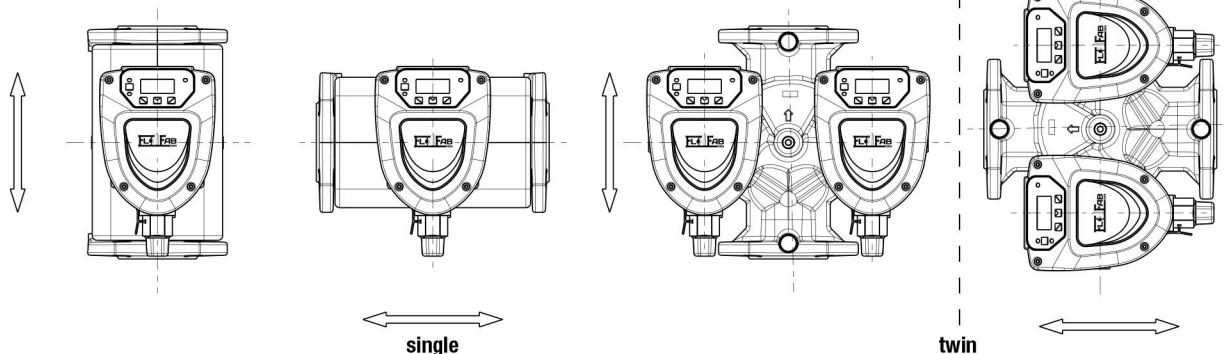

## ● Connection Diagram

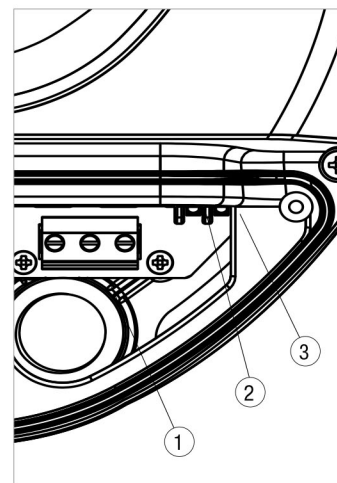
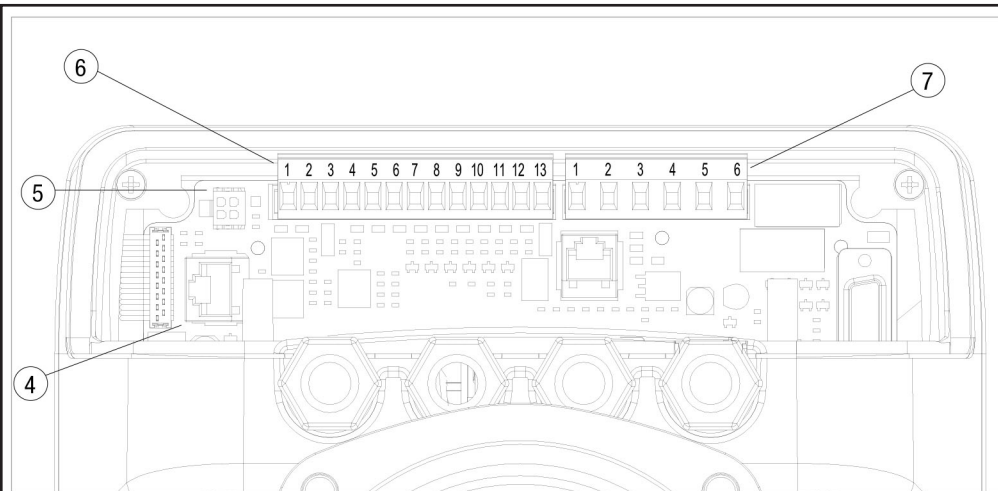

1	Pull-out terminal board for connection of the supply line: 1x220-240 V, 50/60 Hz
2	Auxiliary LED
3	System live indicating LED
4	Connector for connecting twin circulators
5	Connector for connecting the pressure and temperature sensor on the circulator (standard)
6	Pull-out 13-pole terminal board for connecting the inputs and the MODBUS systems
7	Pull-out 6-pole terminal board for alarm signals and system status

### POWER SUPPLY CONNECTION

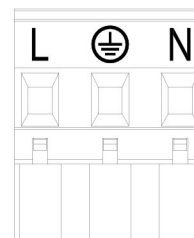

Pull-out terminal board for supply

### CONTROL PANEL DESCRIPTION

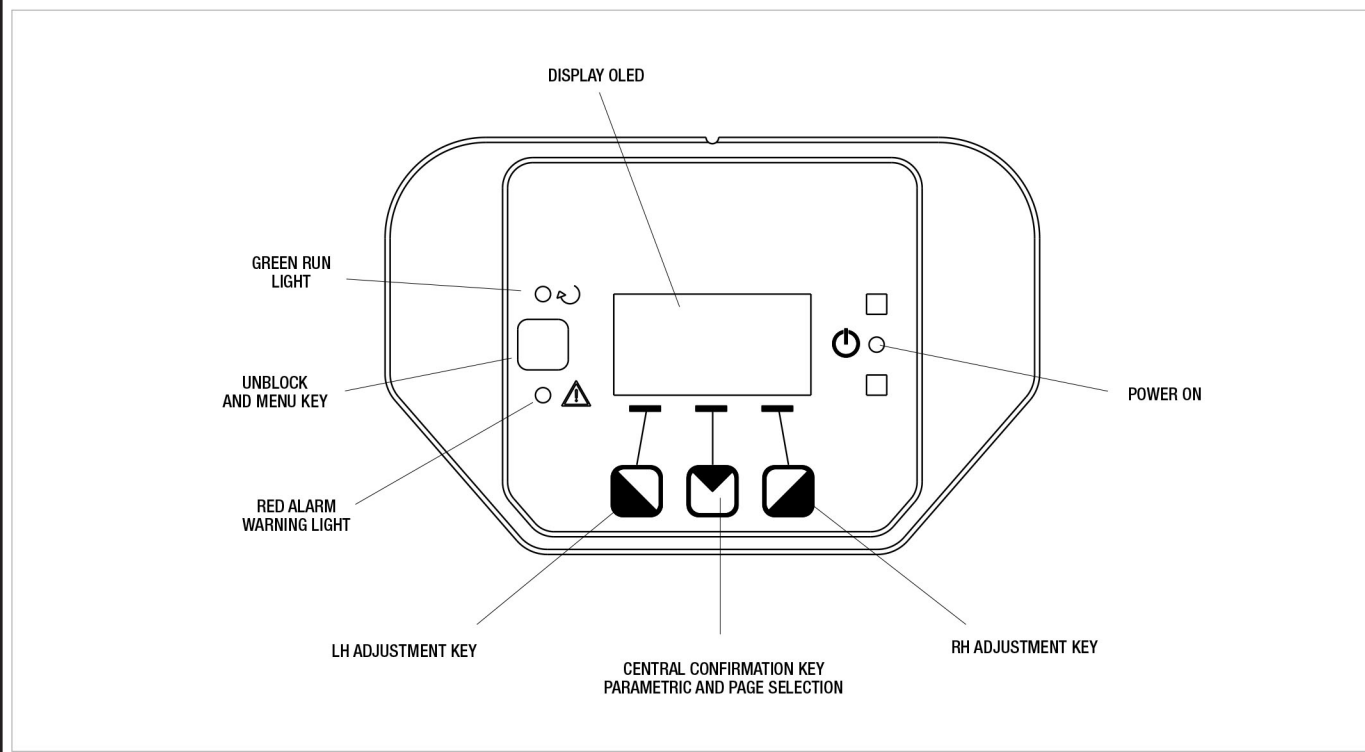

## Digital Inputs

### Digital inputs

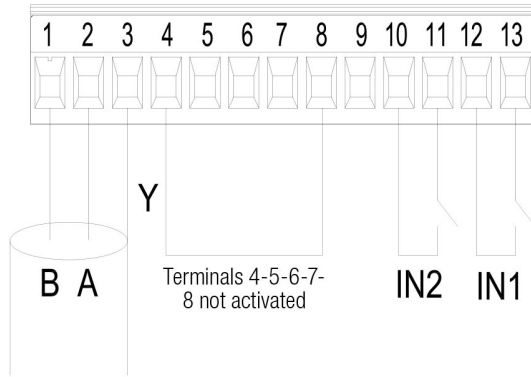

Input	Terminal No.	Type of contact	Associated function
IN1	12	Clean contact	<b>EXT:</b> If it is activated from the control panel it will be possible to command the switching on and off of the pump in remote mode.
	13		
IN2	10	Clean contact	<b>Economy:</b> If it is activated from the control panel it will be possible to activate the set-point reduction function in remote mode.
	11		

If the **EXT** and **Economy** functions have been activated from the control panel, the system will behave as follows:

IN1	IN2	System status
Open	Open	Pump stopped
Open	Closed	Pump stopped
Closed	Open	Pump running with set-point set by the user
Closed	Closed	Pump running with reduced set-point

### MODBUS

FLO FAB circulators provide serial communication through an input RS-485. The communication is realised according to MODBUS specifications. With MODBUS it is possible to set the circulator operating parameters in remote mode such as, for example, the desired differential pressure, the influence of temperature, the regulating mode, etc. At the same time the circulator can provide important information on the system status.

Modbus Terminals	Terminal No.	Description
A	2	Terminal not inverted (+)
B	1	Terminal inverted (-)
Y	3	GND

### LONBUS

With some modules on the market it is possible to make the circulator available also to a LonWorks network, and therefore its status and the possibility of varying the circulator parameters, reading or modifying the registers as described in the Manual "Instructions for use of the Modbus Protocol" available at the address „<http://www.dabpumps.it/evoplus>“.

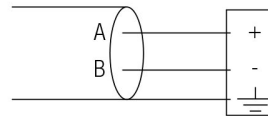

Gateway/FLO FAB connection

### ANALOGUE INPUT AND PWM

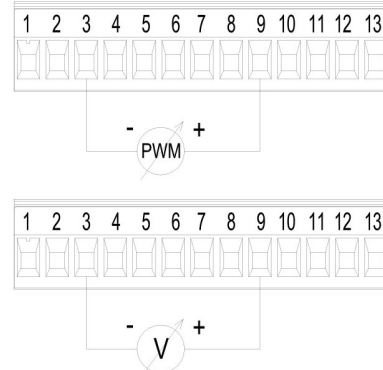

The wiring diagram of the external signals 0-10V and PWM. The 2 signals share the same terminals on the terminal board, so they are mutually exclusive.

### Digital Outputs

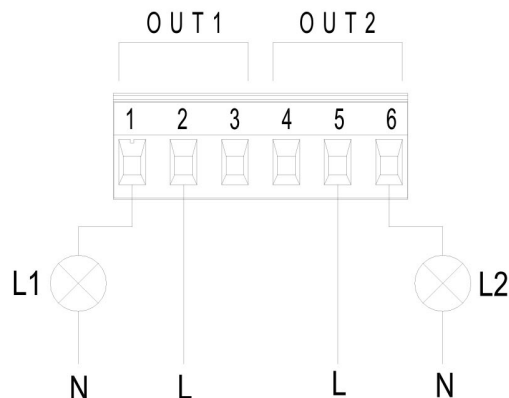

The light L1 is lit when there is an alarm in the system and it goes off when no kind of malfunction is found, whereas the light L2 is lit when the pump is running and goes off when the pump is stopped.

Output	Terminal No.	Type of contact	Associated function
OUT1	1	NC	Presence/Absence of alarms in the system
	2	COM	
	3	NO	
OUT2	4	NC	Pump running/Pump stopped
	5	COM	
	6	NO	

The outputs OUT1 and OUT2 are available on the pull-out 6-pole terminal board which also shows the type of contact (NC = Normally Closed, COM = Common, NO = Normally Open).

#### Characteristics of the output contacts

Max. bearable voltage [V]	250
Max. bearable current [A]	5 - If resistive load 2,5 - If inductive load
Max. accepted cable section [mm <sup>2</sup> ]	1,5





# SERIES 500 PUMPS

## ● Model 100/280.50 - VFD

Model	Center Distance	Counterflanges on request	Voltage 50/60Hz	P1 Max W	In A	EEI	Minimum head pressure			Weight
							t°	90°	100°	
500-2x2-FF-100/280.50-VFD	280 mm	DN 50 PN10	220/240V	430	2.1	EEI≤0.20	m.c.a.	20	25	22kg
	11.02 in								48.5lbs	

Liquid temperature range: da -10°C a +110°C - Maximum operating pressure: 16 bar (1600 kPa)

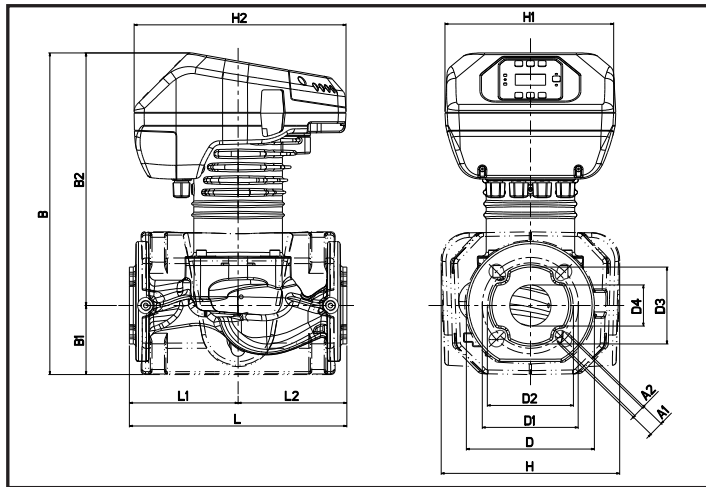

Dimensions in mm							
L	L1	L2	A1	A2	B	B1	B2
280	140	140	19	14	413	87	325
D	D1	D2	D3	D4	H	H1	H2
165	125	110	99	53	230	220	273

Dimensions in inches							
L	L1	L2	A1	A2	B	B1	B2
11.02	5.51	5.51	0.75	0.55	16.26	3.43	12.80
D	D1	D2	D3	D4	H	H1	H2
6.50	4.92	4.33	3.90	2.09	9.06	8.66	10.75

The performance curves are based on kinematic viscosity values = 1 mm<sup>2</sup>/s and density equivalent to 1000 kg/m<sup>3</sup>. Tolerance of curves to ISO 9906. Constant curve available on DNA.

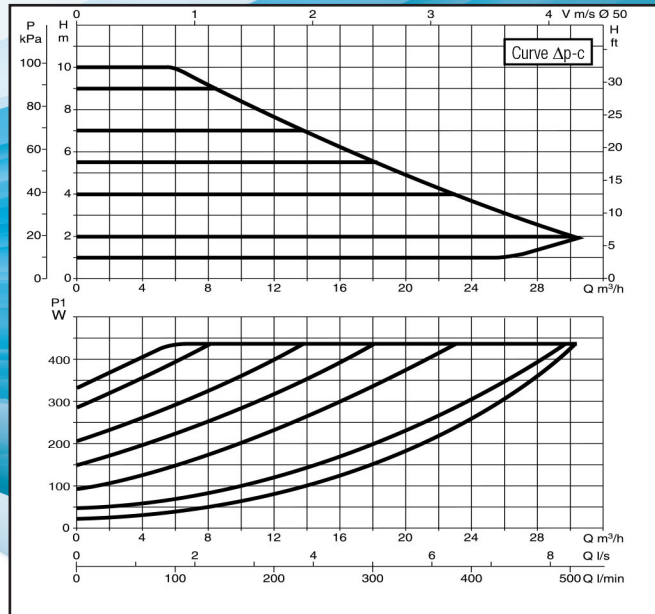
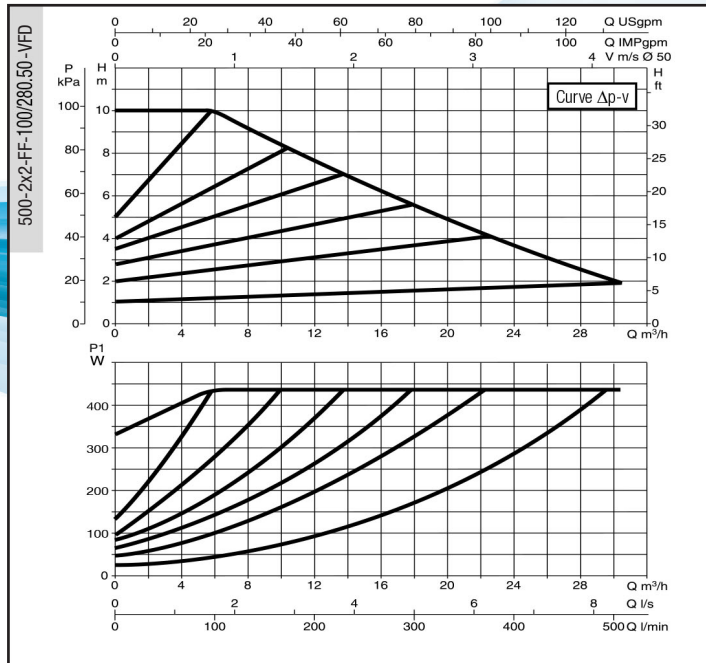

## ● Model 180/280.50 - VFD

Model	Center Distance	Counterflanges on request	Voltage 50/60Hz	P1 Max W	In A	EEI	Minimum head pressure			Weight
							t°	90°	100°	
500-2x2-FF-180/280.50-VFD	280 mm	DN 50 PN10	220/240V	750	3.45	EEI≤0.19	m.c.a.	20	25	22.8kg
	11.02 in								50.27lbs	

Liquid temperature range: da -10°C a +110°C - Maximum operating pressure: 16 bar (1600 kPa)

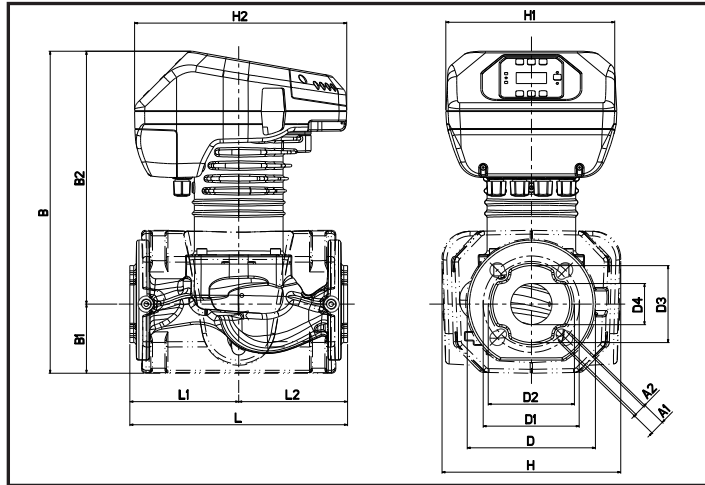

Dimensions in mm							
L	L1	L2	A1	A2	B	B1	B2
280	140	140	19	14	413	87	325
D	D1	D2	D3	D4	H	H1	H2
165	125	110	99	53	230	220	273

Dimensions in inches							
L	L1	L2	A1	A2	B	B1	B2
11.02	5.51	5.51	0.75	0.55	16.26	3.43	12.80
D	D1	D2	D3	D4	H	H1	H2
6.50	4.92	4.33	3.90	2.09	9.06	8.66	10.75

The performance curves are based on kinematic viscosity values = 1 mm<sup>2</sup>/s and density equivalent to 1000 kg/m<sup>3</sup>. Tolerance of curves to ISO 9906. Constant curve available on DNA.

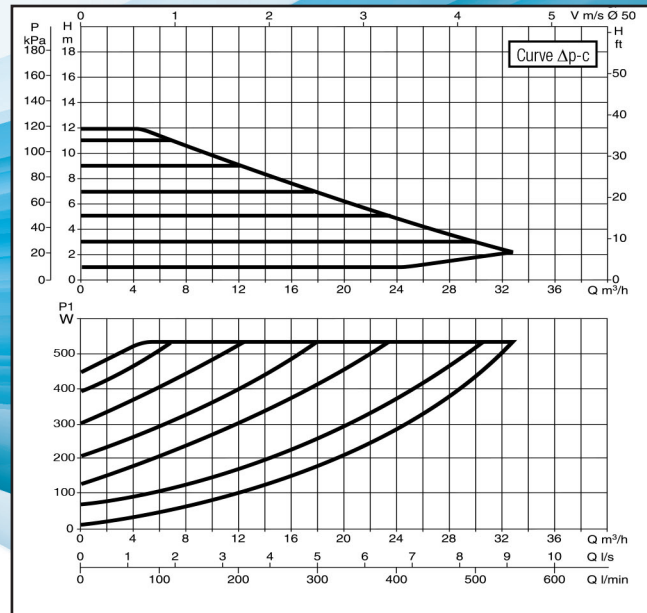
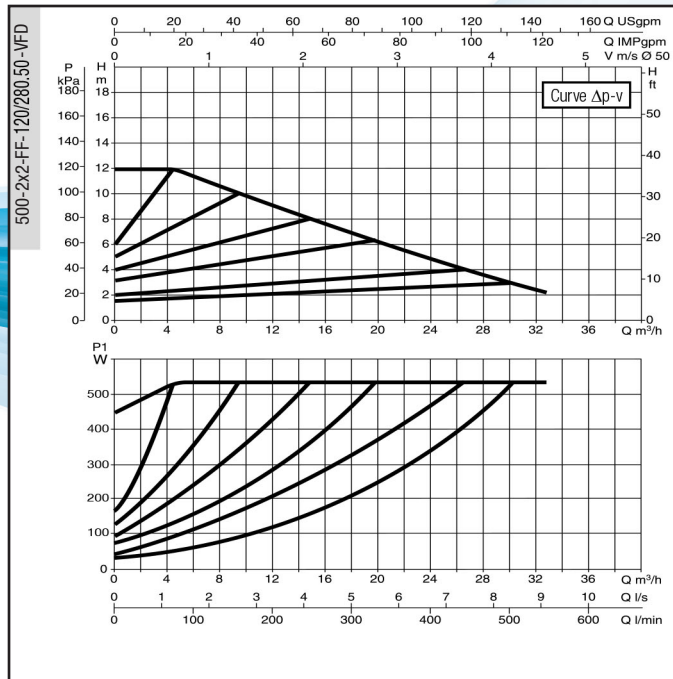



# SERIES 500 PUMPS

## ● Model 150/340.65 - VFD

Model	Center Distance	Counterflanges on request	Voltage 50/60Hz	P1 Max W	In A	EEI	Minimum head pressure			Weight
							t°	90°	100°	
500-2.5x2.5-FF-150/340.65-VFD	340 mm	DN 65 PN10	220/240V	1210	5.5	EEI≤0.18	m.c.a.	20	25	27kg
	13.39 in								59.52lbs	

Liquid temperature range: da -10°C a +110°C - Maximum operating pressure: 16 bar (1600 kPa)

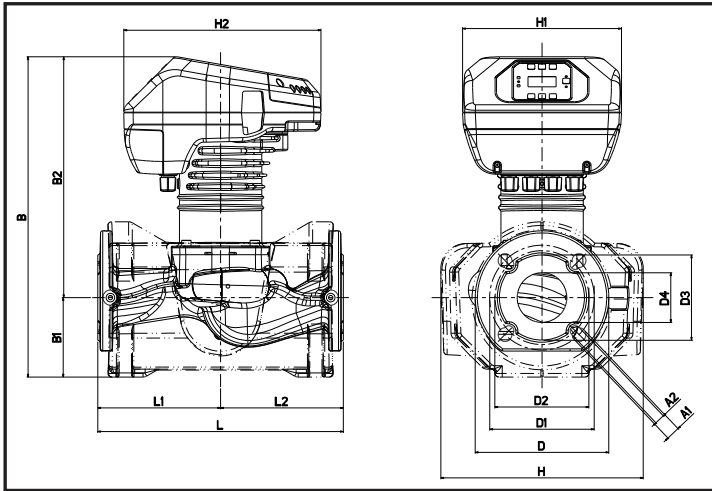

Dimensions in mm							
L	L1	L2	A1	A2	B	B1	B2
340	170	170	19	14	443	110	333
D	D1	D2	D3	D4	H	H1	H2
185	145	130	118	69	280	220	273

Dimensions in inches							
L	L1	L2	A1	A2	B	B1	B2
13.39	6.69	6.69	0.75	0.55	17.44	4.33	13.11
D	D1	D2	D3	D4	H	H1	H2
7.28	5.71	5.12	4.65	2.72	11.02	8.66	10.75

The performance curves are based on kinematic viscosity values = 1 mm<sup>2</sup>/s and density equivalent to 1000 kg/m<sup>3</sup>. Tolerance of curves to ISO 9906. Constant curve available on DNA.

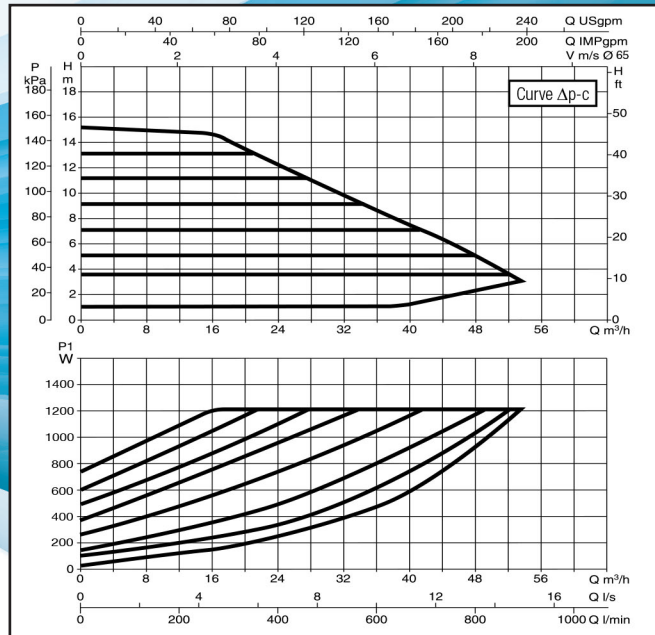
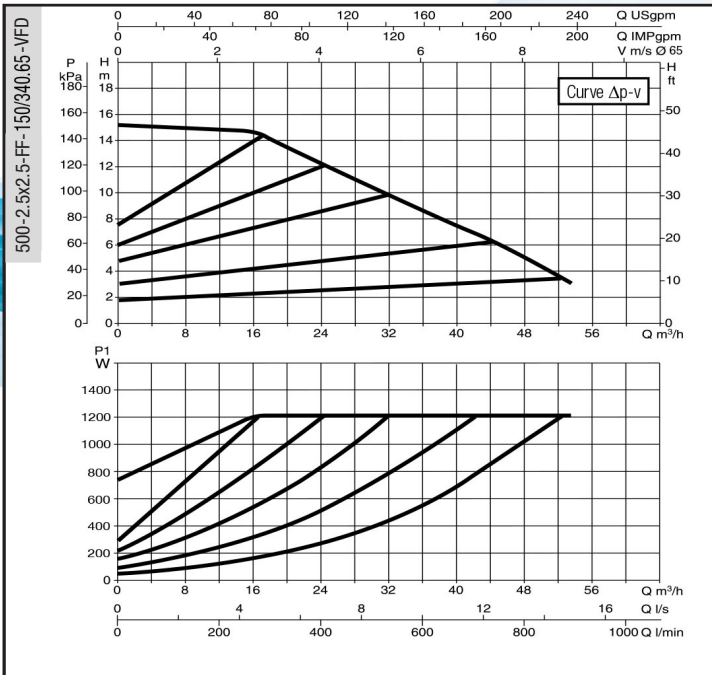



- **Package It**

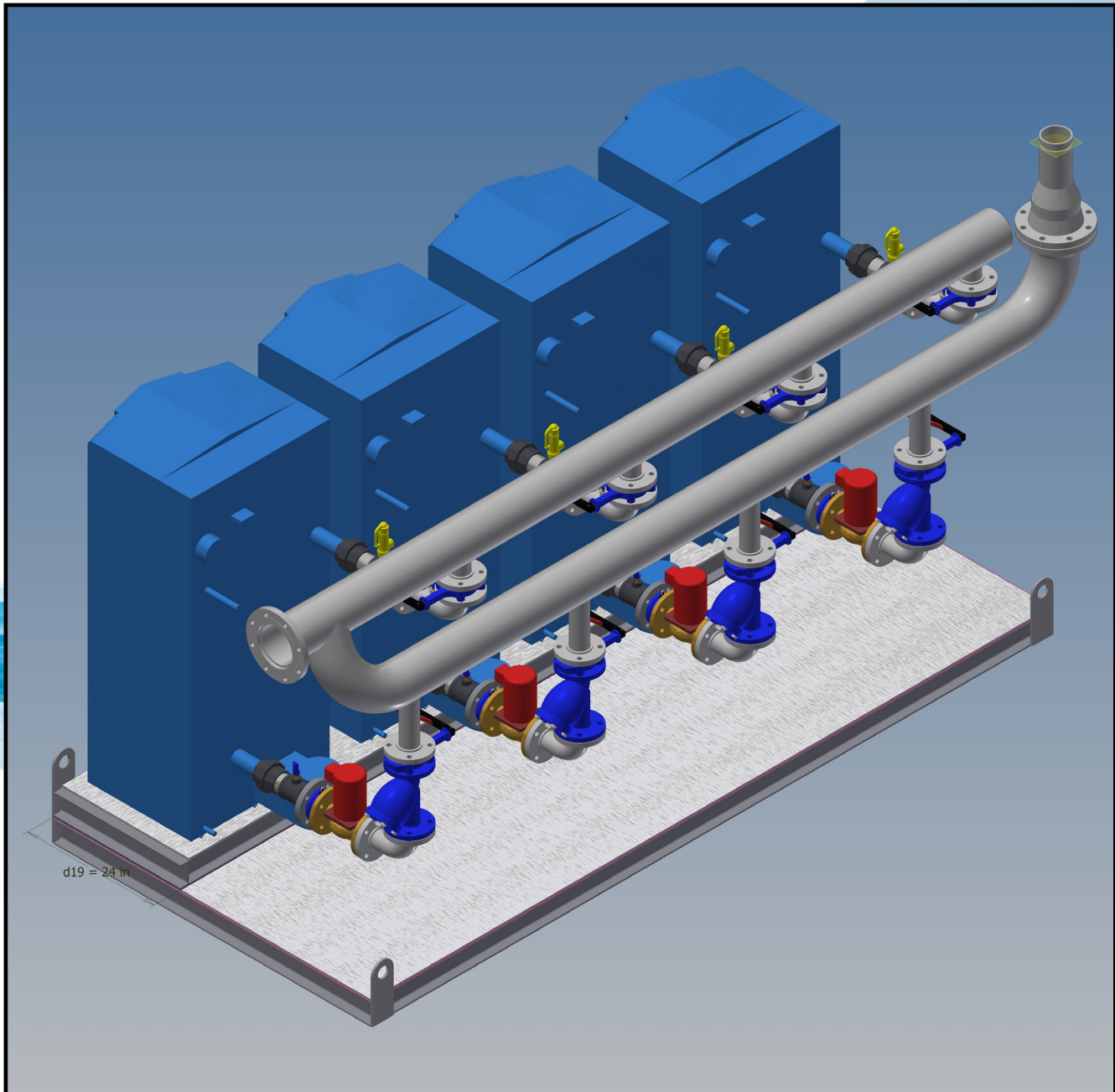

- **Other System**

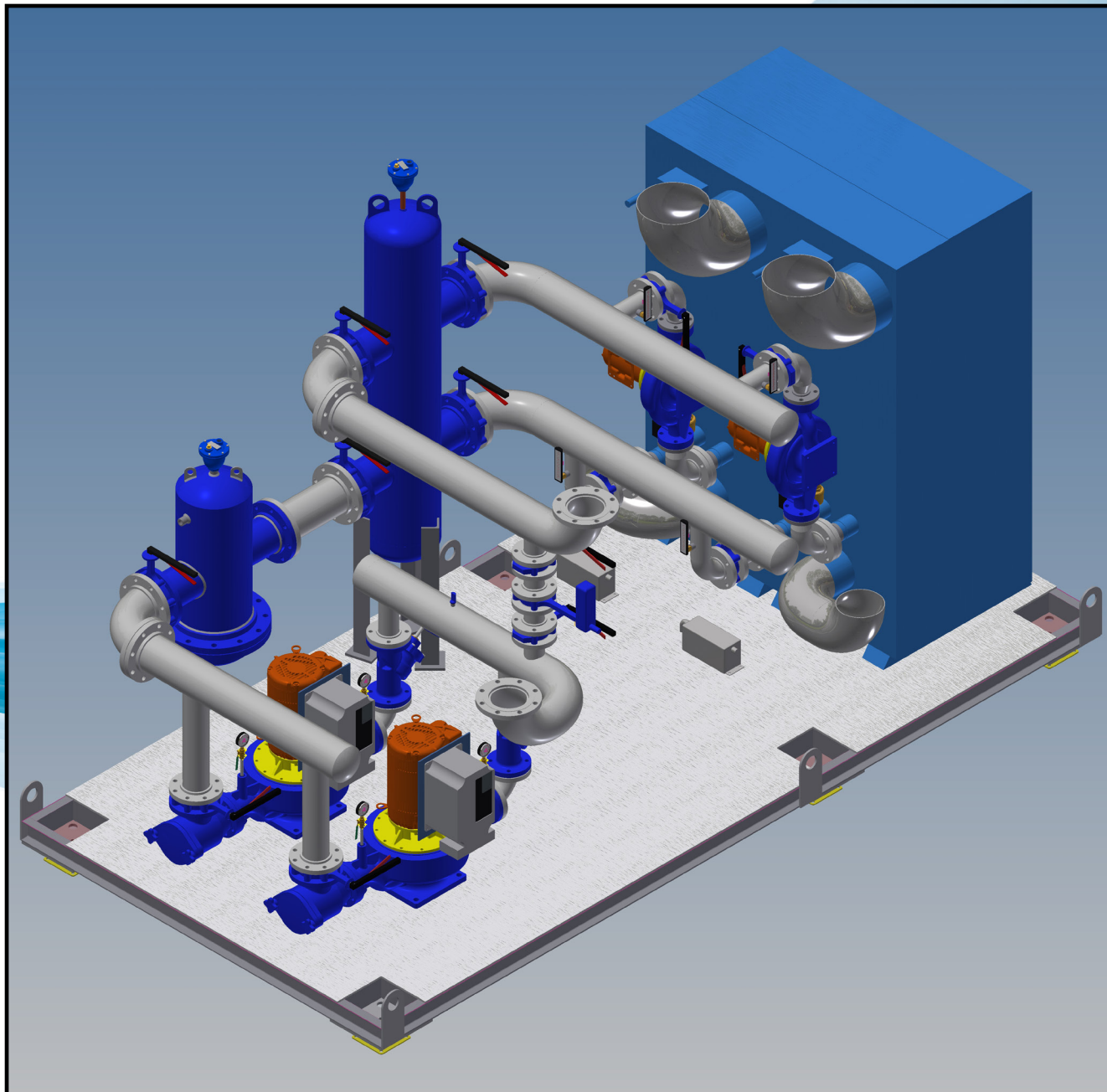

- **Other System**

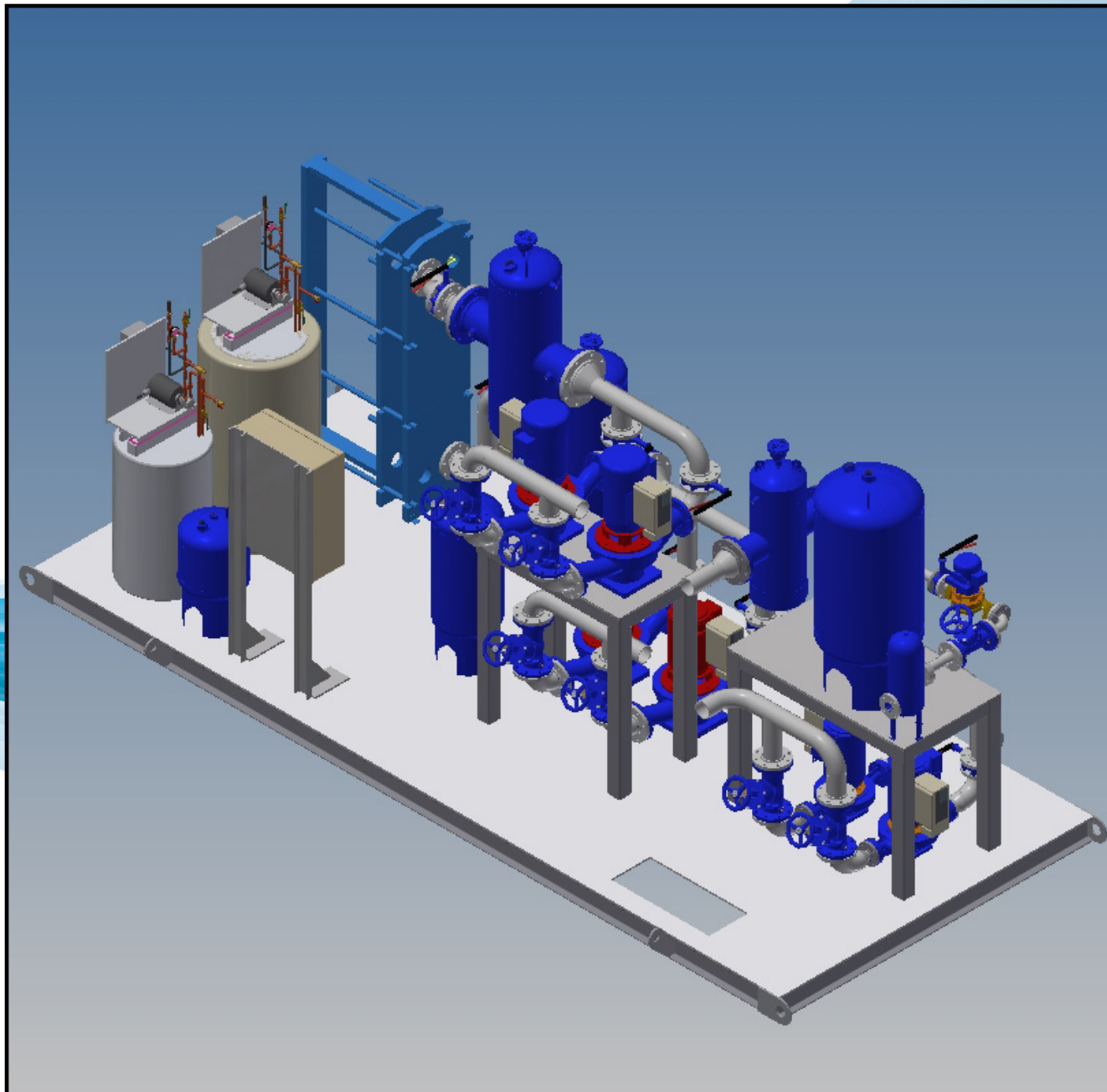



We are proud supplier for the following  
completed and on going projects :



**Research and Medical Clinic**  
4508 E. 41st Street  
Tulsa, OK, USA 74135  
Engineer: Engineering Design Associates,  
Tulsa, OK



**Muskogee Regional  
Medical Center**  
300 Rockerfeller Drive  
Muskogee, OK, USA 74401  
Engineer: Lee & Browne  
Consulting Engineers Tulsa, OK



**The Gazette**  
1010 Ste-Catherine St.  
West, Suite 200, Montréal,  
Québec, CA



**Wawanesa**  
8585 Decarie Boulevard,  
Mont-Royal, QC, CA

## Sales and Service:

Quebec, Canada  
Tel. : (450) 621-2995  
Fax : (450) 621-4995

Lake Worth  
Florida, USA  
33467-5749

Toronto, Canada  
Tel. : +1 (647) 544-2995

[www.flofab.com](http://www.flofab.com)

SERVICE 24/7 : [parts@flofab.com](mailto:parts@flofab.com)

