



MODEL # RWUH-30-085

Design Notes

Code..... ASME Sec IV HLW
 Design Pressure..... 125 psi
 Test Pressure..... 125 psi
 Interior..... Glass Lining
 Exterior..... Baked Enamel Steel Jacket
 Insulation..... 2" R-12 Open cell foam
 Supports..... Saddles
 Capacity..... 240 Gal. / 260 nominal
 Weight..... 755 Lbs.

Material Specifications

Heads..... Carbon Steel
 Shell..... Carbon Steel
 Jacket..... 24 Gauge Steel
 Couplings..... Carbon Steel
 Flanges..... N/A
 Pipe..... N/A
 Manway..... N/A

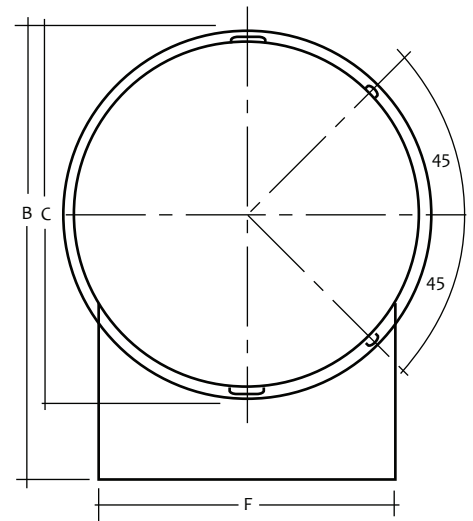
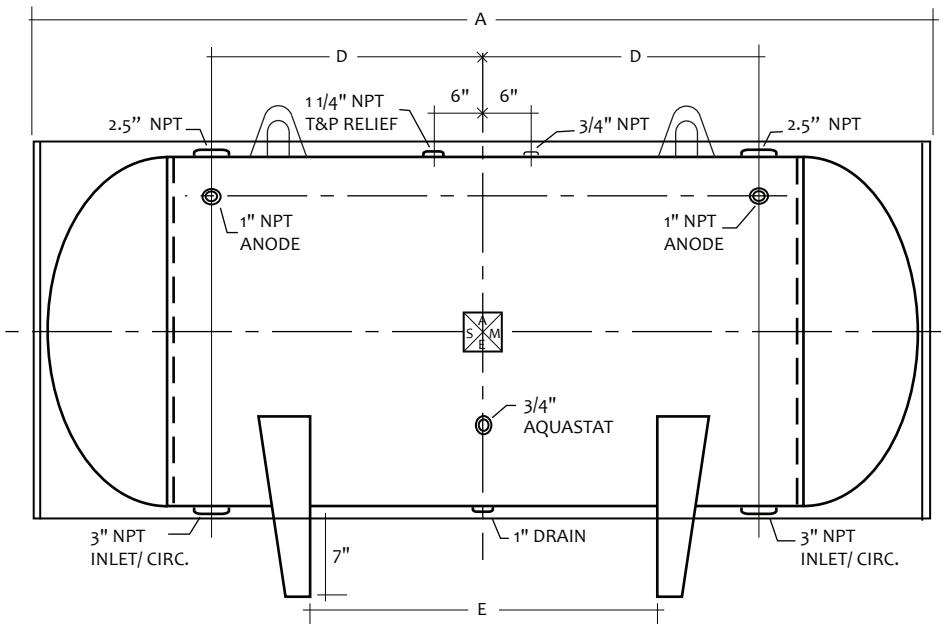

HORIZONTAL STORAGE TANK

Mark	Dimension	Remark	NOTES
A	89"	Overall length	PROJECT
B	41"	Overall height	CUSTOMER
C	34"	Diameter	SCALE Not to Scale
D	29"	Circulation	DATE
E	34"	Supports	CUSTOMER P.O. #
F	26.38"	Support width	DRAWING Rev NO.