

MODEL # RWUH-36-114

Design Notes

Code..... ASME Sec IV HLW
 Design Pressure..... 125 psi
 Test Pressure..... 125 psi
 Interior..... Glass Lining
 Exterior..... Baked Enamel Steel Jacket
 Insulation..... 2" R-12 Open cell foam
 Supports..... Saddles
 Capacity..... 465 Gal. / 502 nominal
 Weight..... 1157 Lbs.

Material Specifications

Heads..... Carbon Steel
 Shell..... Carbon Steel
 Jacket..... 24 Gauge Steel
 Couplings..... Carbon Steel
 Flanges..... N/A
 Pipe..... N/A
 Manway..... N/A

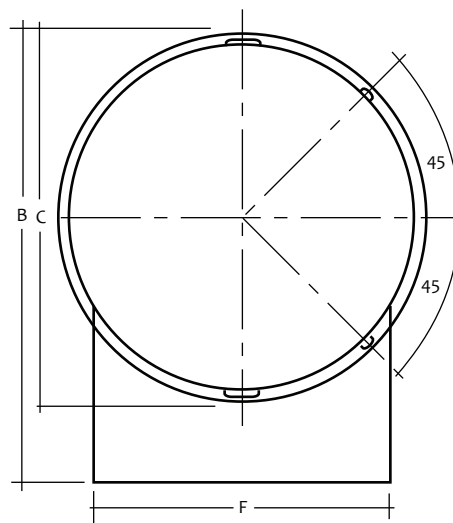
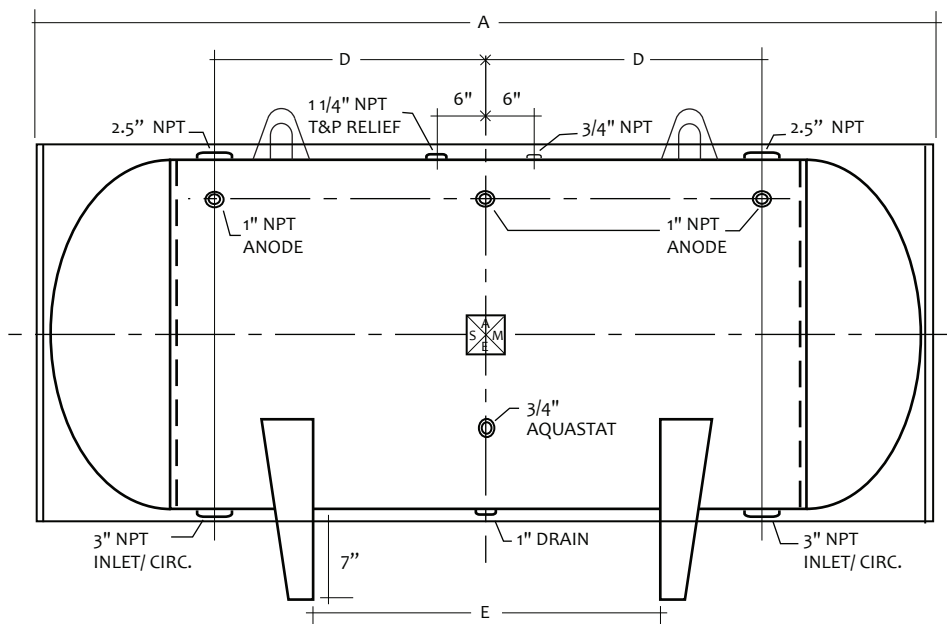

HORIZONTAL STORAGE TANK

Mark	Dimension	Remark	NOTES
A	118"	Overall length	PROJECT
B	47"	Overall height	CUSTOMER
C	40"	Diameter	SCALE Not to Scale
D	42"	Circulation	DATE
E	60"	Supports	CUSTOMER P.O. #
F	31.69"	Support width	DRAWING Rev NO.