

# MODEL # RWUH-48-084

## Design Notes

Code..... ASME Sec IV HLW  
 Design Pressure..... 125 psi  
 Test Pressure..... 125 psi  
 Interior..... Glass Lining  
 Exterior..... Baked Enamel Steel Jacket  
 Insulation..... 2" R-12 Open cell foam  
 Supports..... Saddles  
 Capacity..... 580 Gal. / 658 nominal  
 Weight..... 1593 Lbs.

## Material Specifications

Heads..... Carbon Steel  
 Shell..... Carbon Steel  
 Jacket..... 24 Gauge Steel  
 Couplings..... Carbon Steel  
 Flanges..... N/A  
 Pipe..... N/A  
 Manway..... Carbon Steel

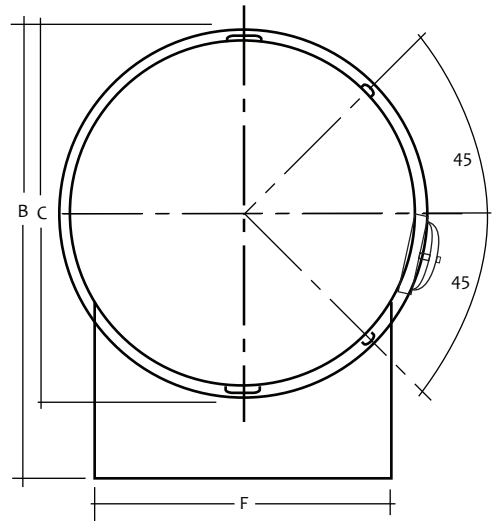
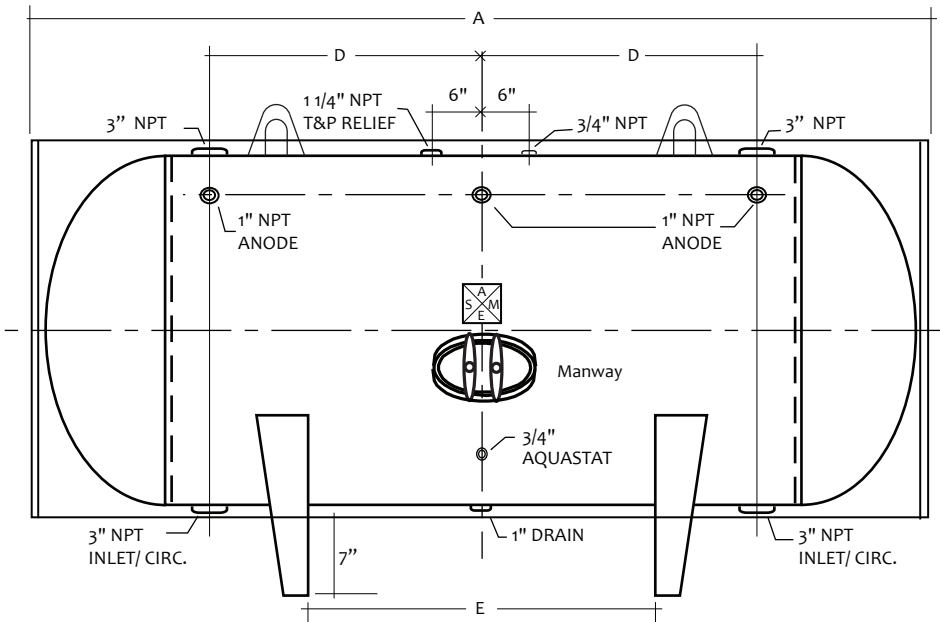

HORIZONTAL STORAGE TANK

Mark	Dimension	Remark	NOTES
A	88"	Overall length	PROJECT
B	59"	Overall height	CUSTOMER
C	52"	Diameter	SCALE Not to Scale
D	24"	Circulation	DATE
E	24"	Supports	CUSTOMER P.O. #
F	42.13"	Support width	DRAWING Rev NO.