

MODEL # RWUH-36-090

Design Notes

Code..... ASME Sec IV HLW
 Design Pressure..... 125 psi
 Test Pressure.....125 psi
 Interior.....Glass Lining
 Exterior.....Baked Enamel Steel Jacket
 Insulation..... 2" R-12 Open cell foam
 Supports..... Saddles
 Capacity.....360 Gal. / 397 nominal
 Weight..... 935 Lbs.

Material Specifications

Heads..... Carbon Steel
 Shell..... Carbon Steel
 Jacket..... 24 Gauge Steel
 Couplings..... Carbon Steel
 Flanges..... N/A
 Pipe..... N/A
 Manway..... N/A

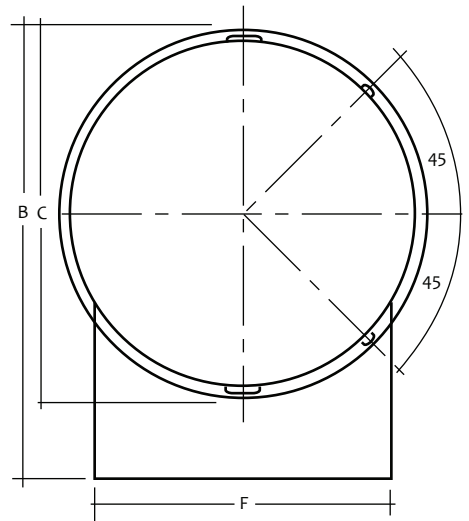
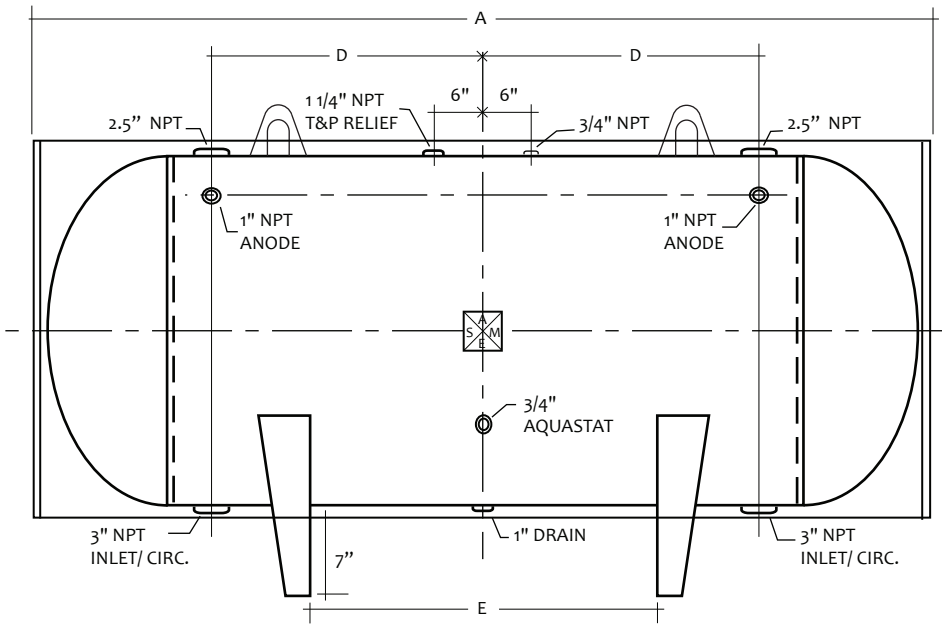

HORIZONTAL STORAGE TANK

Mark	Dimension	Remark	NOTES
A	94"	Overall length	PROJECT
B	47"	Overall height	CUSTOMER
C	40"	Diameter	SCALE Not to Scale
D	30"	Circulation	DATE
E	40"	Supports	CUSTOMER P.O. #
F	31.69"	Support width	DRAWING Rev NO.